

User Manual

GoDEX

DT200(i)(L)+ Series

Thermal Label Printer



DT200(i)(L)+ Series User Manual
P/N:920-019711-00
Version: A.4
Issue date:2024/07/23

CONTENTS

1 Thermal Label Printer	5
1.1 Box Content	5
1.2 Getting to know your printer.....	6
2 Printer Setup.....	9
2.1 Loading the label(The following uses the DT200iL+ series for explanation).....	9
2.2 Switching label roll holder.....	13
2.3 Connecting the Printer to the Host Computer.....	14
2.4 Installing printer driver and GoLabel II	15
3 Printer Setting and Control	20
3.1 Operation Panel Introduction	20
3.2 LED Status (DT200+/DT200L+ Series).....	21
3.3 Error Alerts	22
3.4 LCD Interface Introduction(DT200i+/DT200iL+ Series).....	23
3.5 LAN Setting(DT200i+/DT200iL+ Series).....	28
3.6 LCD Password (DT200i+/DT200iL+ Series).....	30
3.7 LCD Interface Function(DT200i+/DT200iL+ Series)	32
3.8 Status of LCD Interface (DT200i+/DT200iL+ Series).....	36
3.9 Error Alerts (DT200i+/DT200iL+ Series).....	37
3.10 USB Host.....	39
4. NetSetting for Ethernet	41
4.1 Installing the NetSetting software	41
4.2 The Interface of NetSetting	42
5. Maintenance and Adjustment	49
5.1 Cleaning the Print Head.....	49
5.2 Cleaning the Platen and Label Guide.....	50
5.3 Cleaning the Cutter	51
5.4 Troubleshooting.....	52
Appendix.....	53
DT200+ series Printer Specification	53
Interface	55
File Manipulation When Using USB Stick.....	56

**FCC COMPLIANCE STATEMENT
FOR AMERICAN USERS**

This equipment has been tested and found to comply with the limits for a **Class B** digital device, pursuant to Part 15 of the FCC Rules. These limits are designed to provide reasonable protection against harmful interference in a residential installation. This equipment generates, uses, and can radiate radio frequency energy and, if not installed and used in accordance with the instructions, may cause harmful interference to radio communications.

**TO WHICH THIS DECLARATION RELATES
IS IN CONFORMITY WITH THE FOLLOWING STANDARDS**
IEC 62368-1:2018

EN 55032:2015/A1:2020, Class B	EN55035:2017/A11:2020
EN IEC 61000-3-2:2019/A1:2021	CISPR 35:Ed. 1.0
EN 61000-3-3:2013/A2:2021	
CISPR 32:Ed. 2.1	
AS/NZS CISPR 32:2015 AMD 1:2020	

FCC CFR Title 47 Part 15 Subpart B:2021, Class B
ICES-003 Issue 7:2020, Class B

SAFETY INSTRUCTIONS

Please read the following instructions carefully.

1. Keep the equipment away from humidity.
2. Before you connect the equipment to the power outlet, please check the voltage of the power source.
3. Make sure the printer is off before plugging the power connector into the power jack.
4. It is recommended that you connect the printer to a surge protector to prevent possible transient overvoltage damage.
5. Be careful not to get liquid on the equipment to avoid electrical shock.
6. For safety and warranty reasons, ONLY qualified service personnel should open the equipment.
7. Do not repair or adjust energized equipment under any circumstances.
8. Before disassemble the cutter, please turn off the power and wear the gloves on.

*This device is not suitable for the areas where children may appear



Hot parts!

Burned fingers when handling the parts

Wait one-half hour after switching off before handling parts.



The blade is sharp, please do not touch.

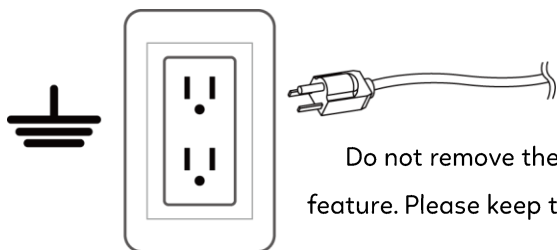

Do not remove the ground pin of power cord. Grounding is an important safety feature. Please keep the power cord grounded all the time

Caution

- Danger of explosion if battery is incorrectly replaced. Replace only with the equivalent type recommended by the manufacturer.
- Dispose of used batteries according to the manufacturer's instructions.
- Only use with designated power supply adapter model.
- Changes or modifications not expressly approved by the party responsible for compliance could void the user's authority to operate the equipment.

Specifications are subject to change without notice.

1 Thermal Label Printer

1.1 Box Content



DT200+ Series

DT200L+ Series



DT200iL+ Series

DT200i+ Series

※Package content may vary per region.

- Power cord

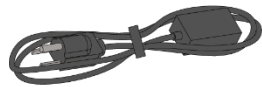

- USB cable



- Power adapter

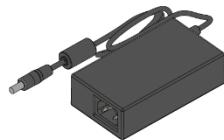

- DT200+ Quick guide



- *Peel detection board

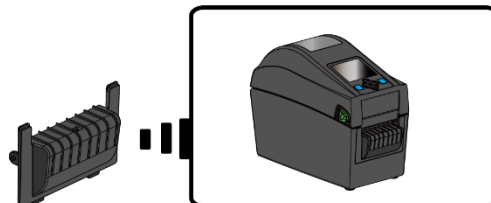

*Only for DT200L+/DT200iL+ Series

1.2 Getting to know your printer

Front View

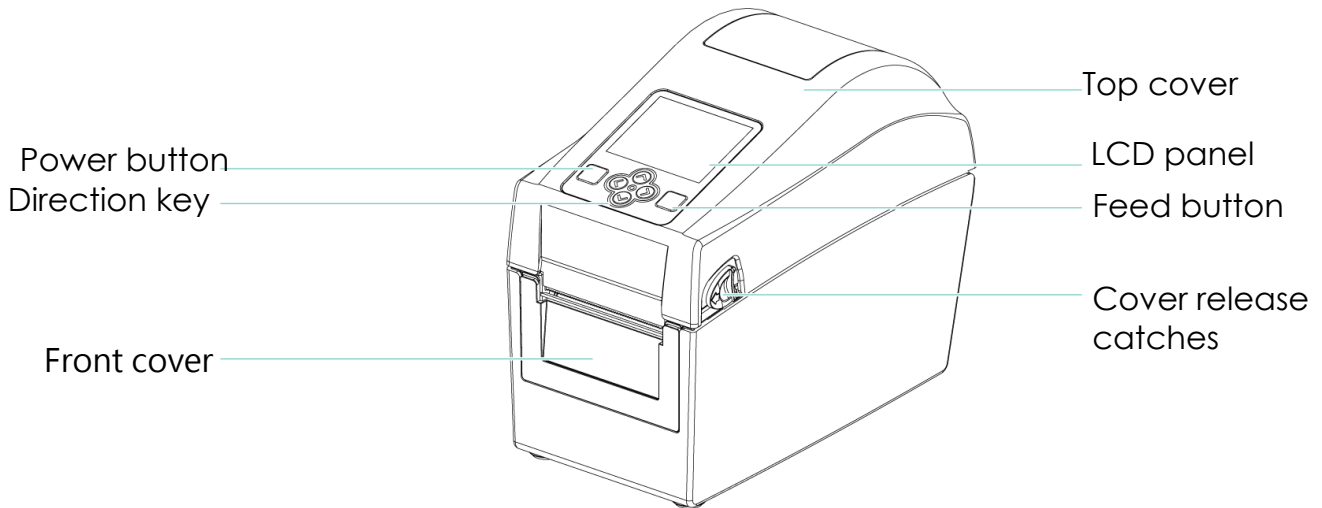

Rear View

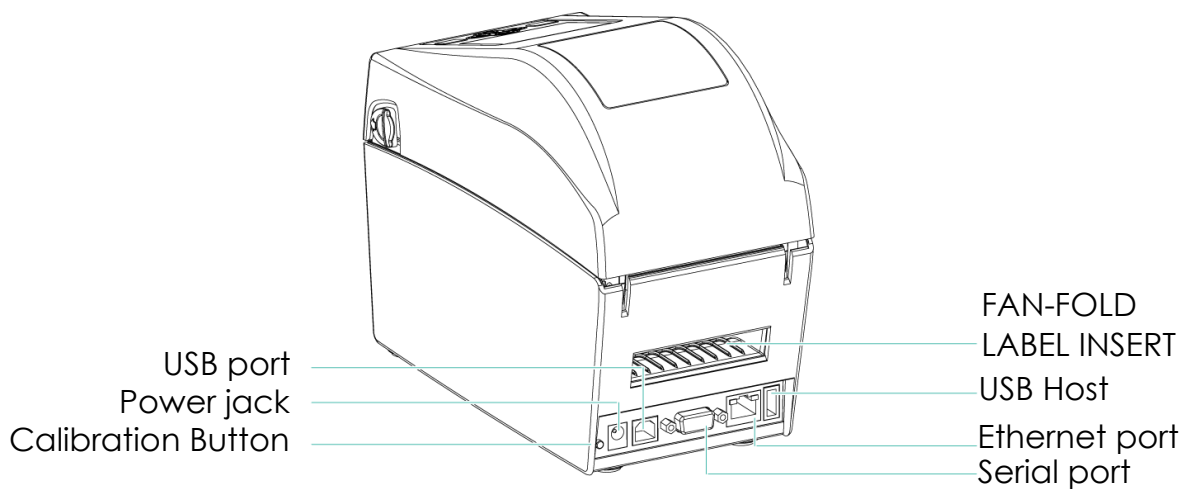

Bottom View

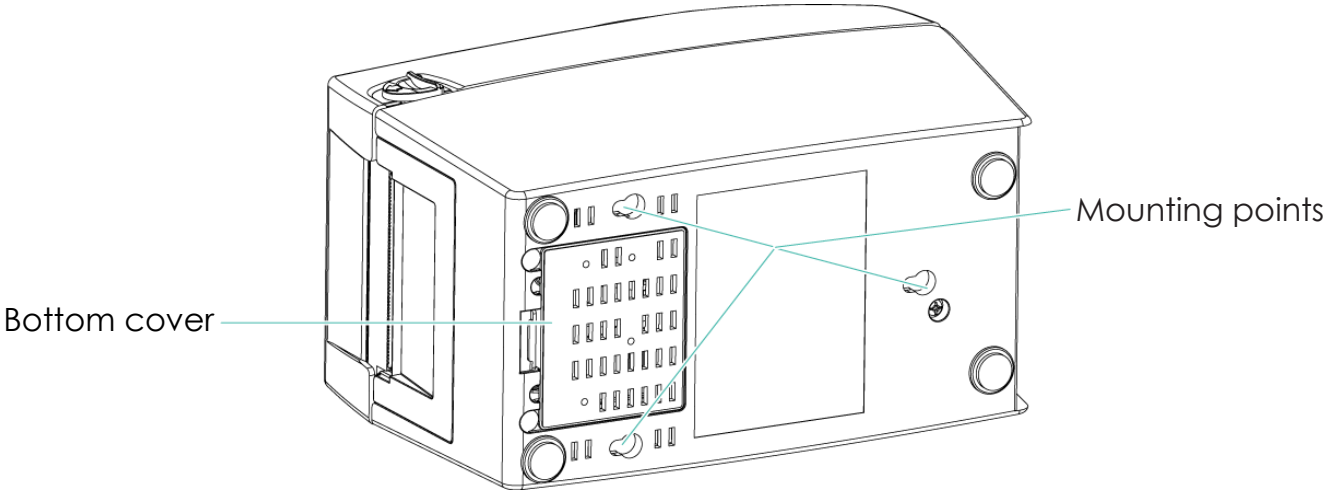

※Specifications of the wall-mounted screws.

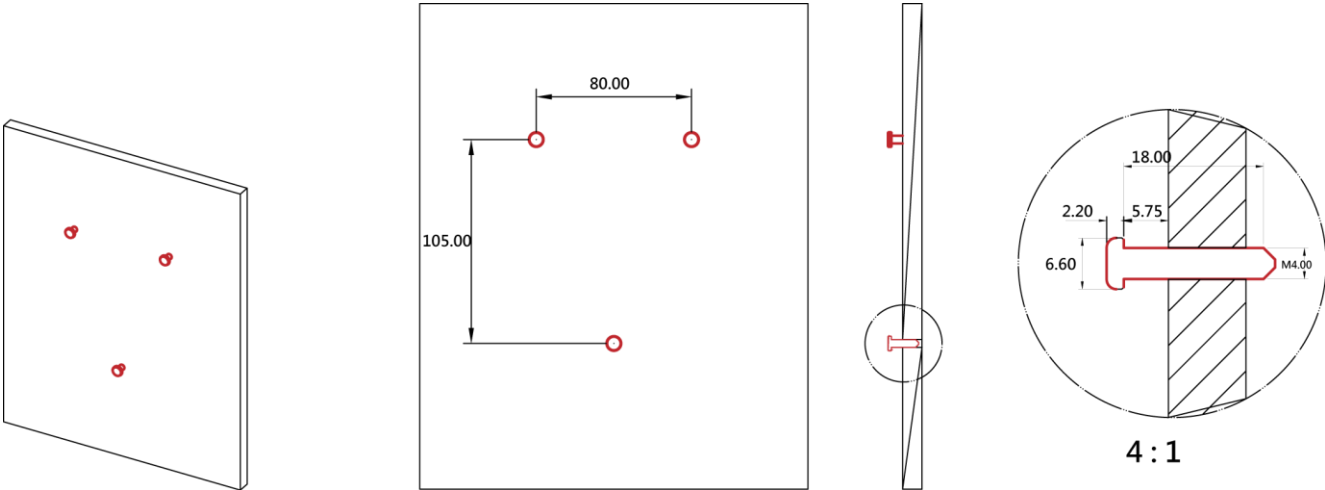

The Internal view of printer

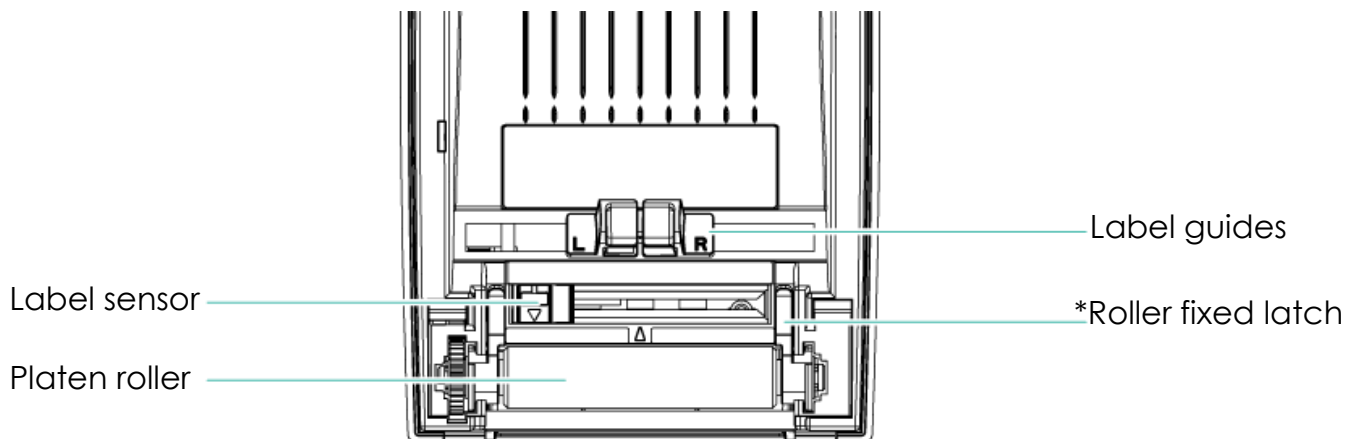
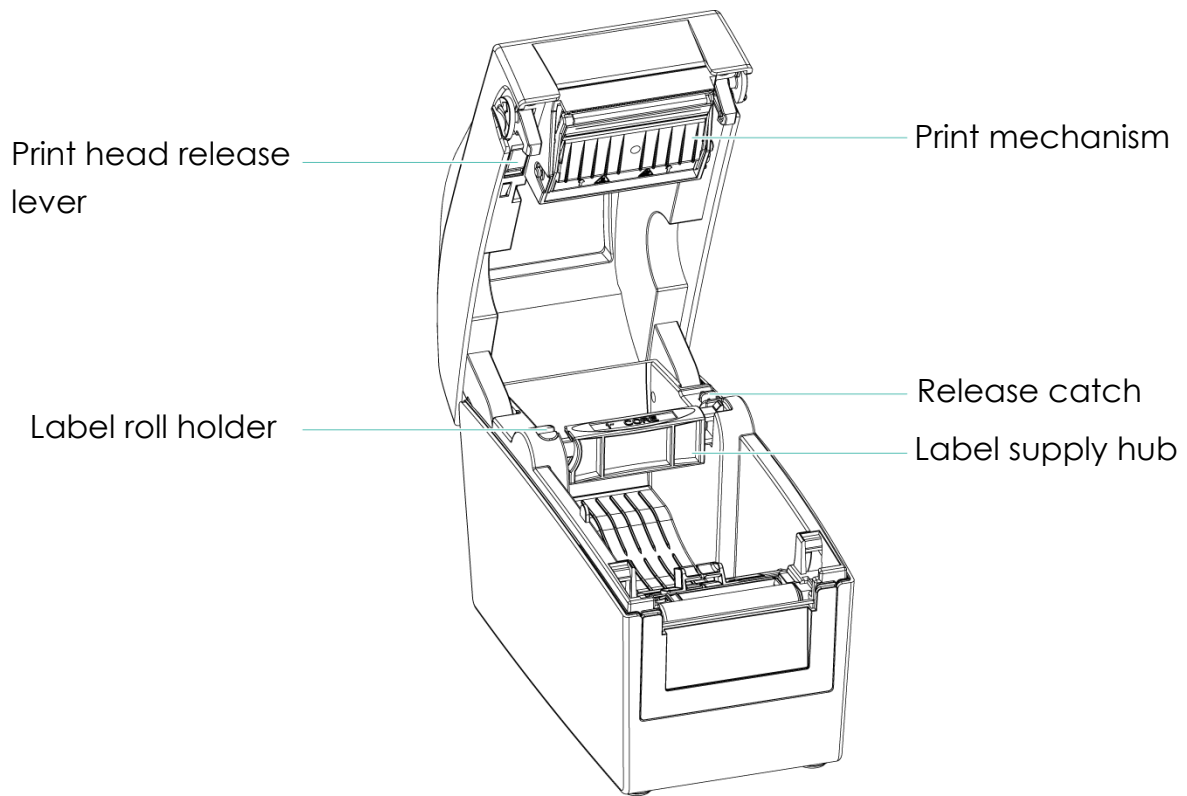

2 Printer Setup

2.1 Loading the label(The following uses the DT200iL+ series for explanation)

1. Place the printer on a flat surface and open the printer cover.

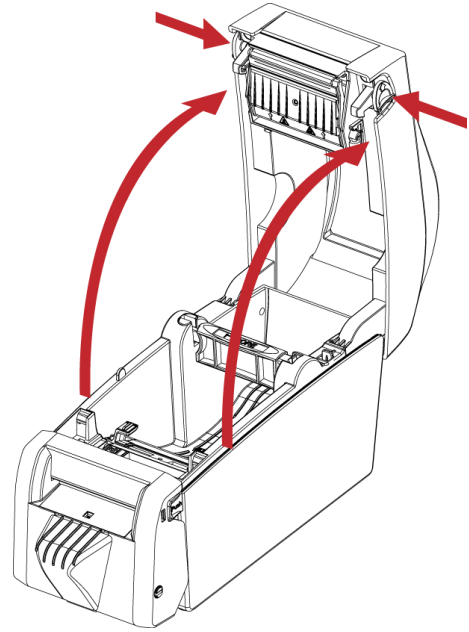

2. Release the label supply hub.

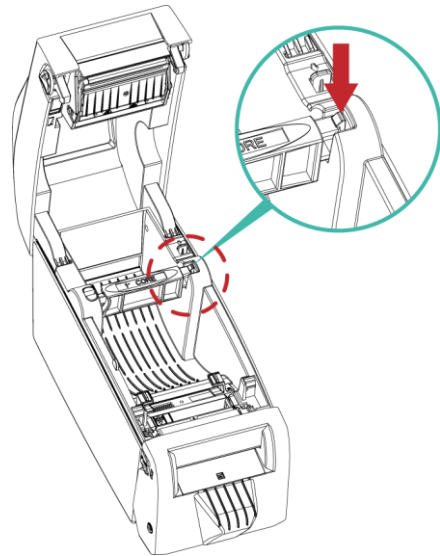

3. Lift the label roll holder and pull it out as far as possible.

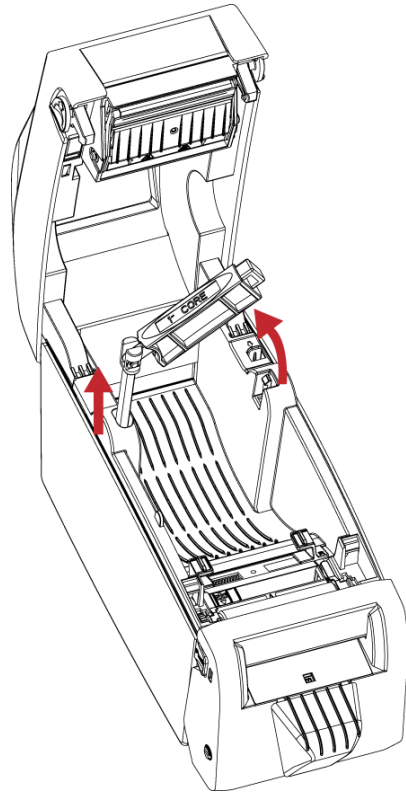

4. Install the label roll on the label supply hub.

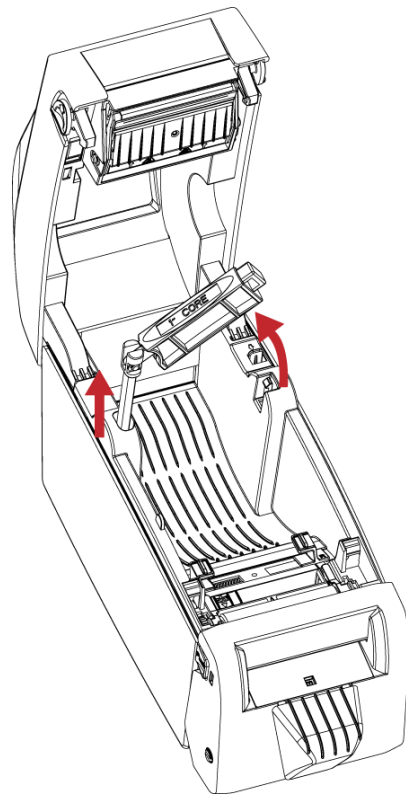

5. Now press the label roll holder down until it clicks into place.

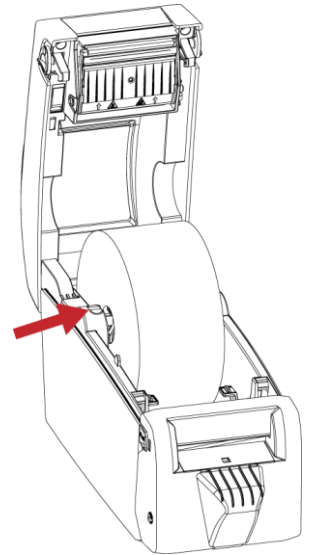
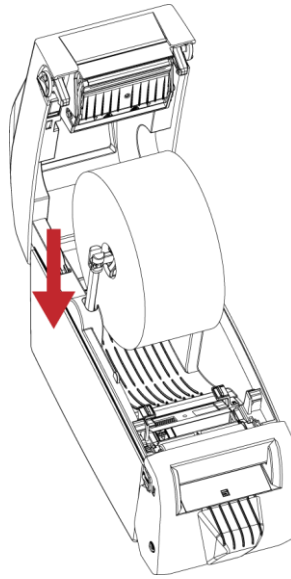

6. Pass the label under the paper guides and pull it forward.

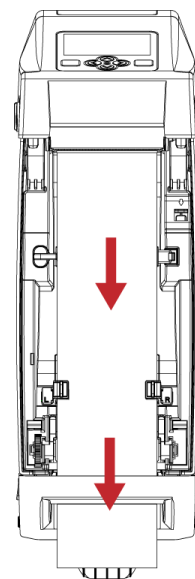
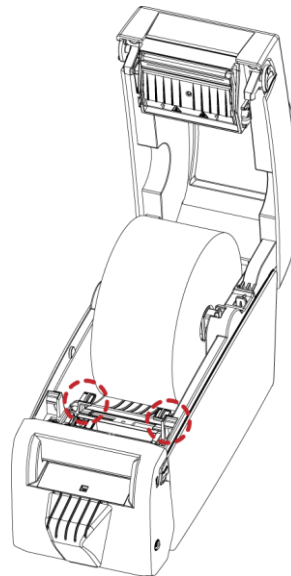

7. Adjust the paper guides to the width of the label liner.

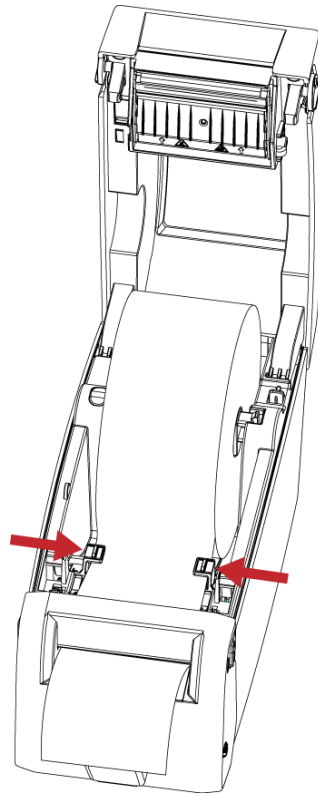

8. Close the printer cover to finish loading the labels

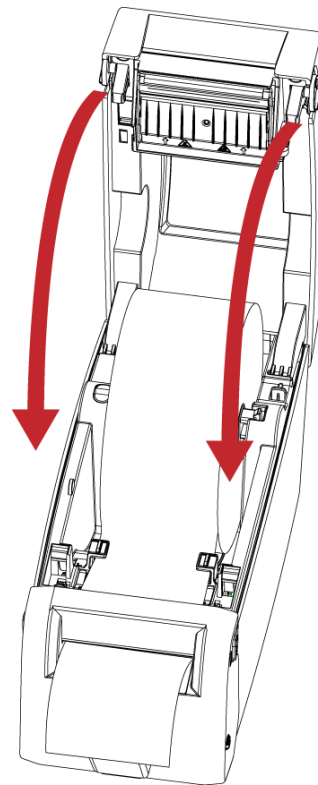

2.2 Switching label roll holder

1. Pull the label roll holder out as far as it will go.

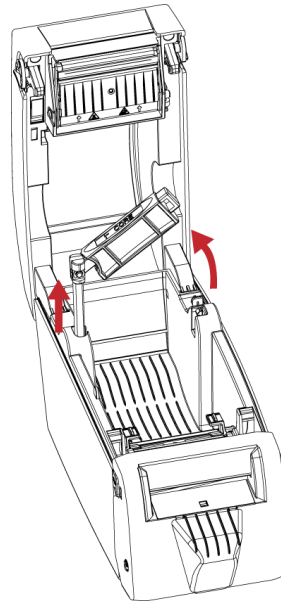

*If the label supply hub is not pulled all the way up, the label supply hub will not rotate.

2. Fold out the label supply hub as shown in the illustration.

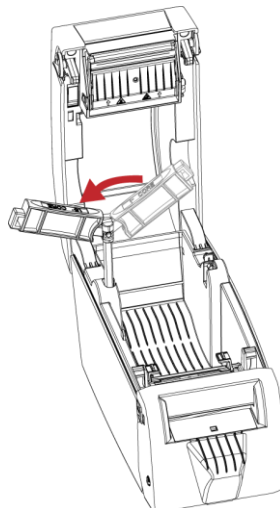

3. Now rotate the label roll holder to return the label supply hub to its original position.
Press down the label supply hub until it clicks into place.

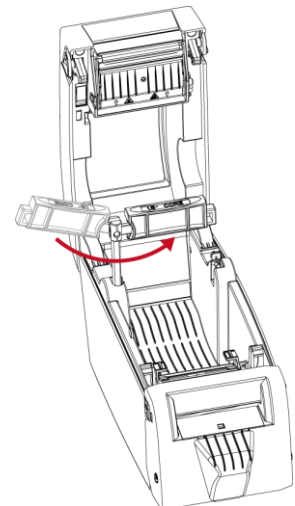

2.3 Connecting the Printer to the Host Computer

1. Please make sure that the printer is switched off.
2. Connect the power cord to the AC adapter and connect the adapter to the printer.
3. Connect the USB cable to the printer and host computer.
4. Switch on the printer. The operator panel should now light up.

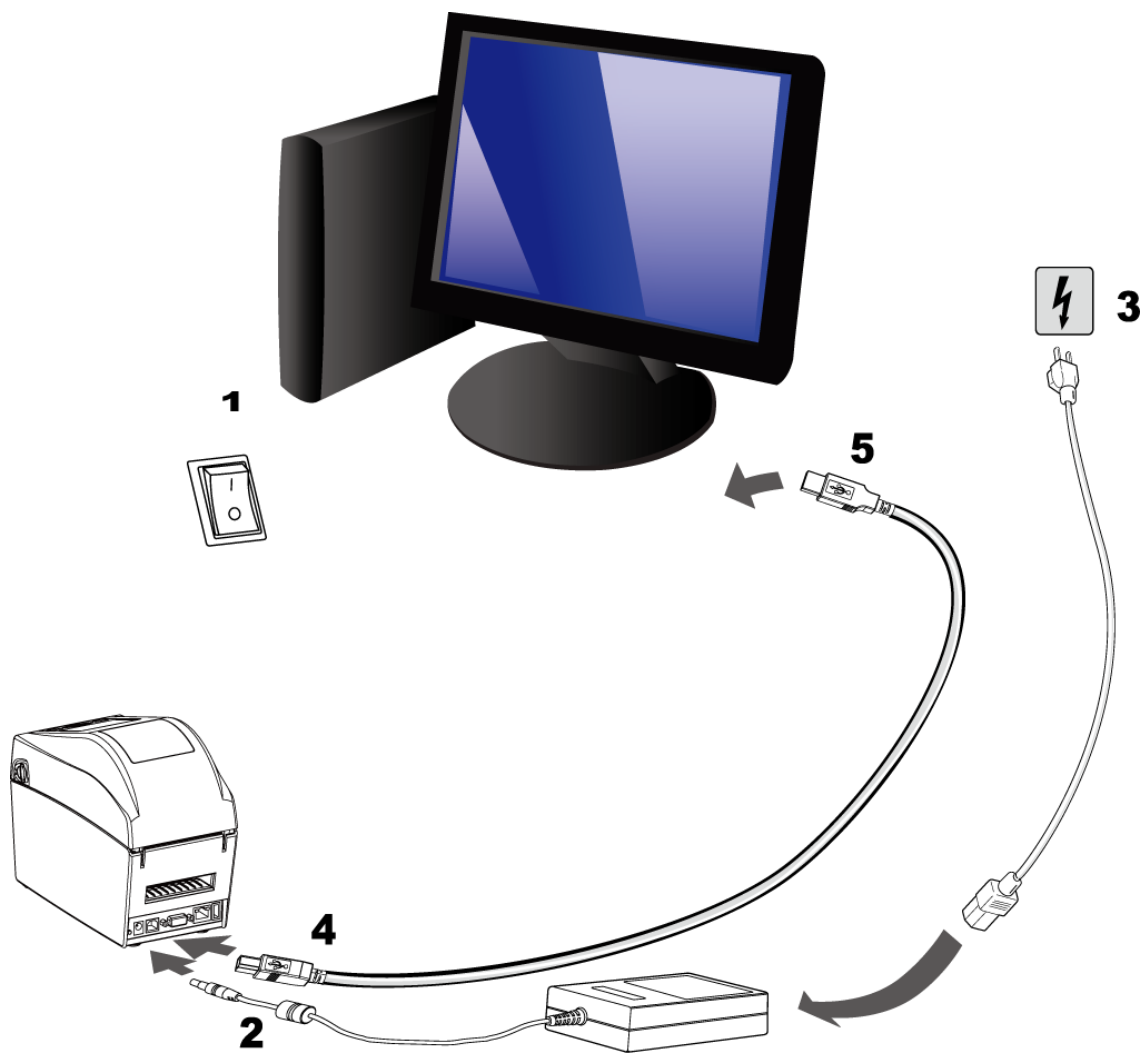

2.4 Installing printer driver and GoLabel II

Relevant documents and software can be found and download on GoDEX official website.

Driver

Step1. Click the compressed driver file in the folder.

Select "I accept the terms in the license agreement." and click "Next".

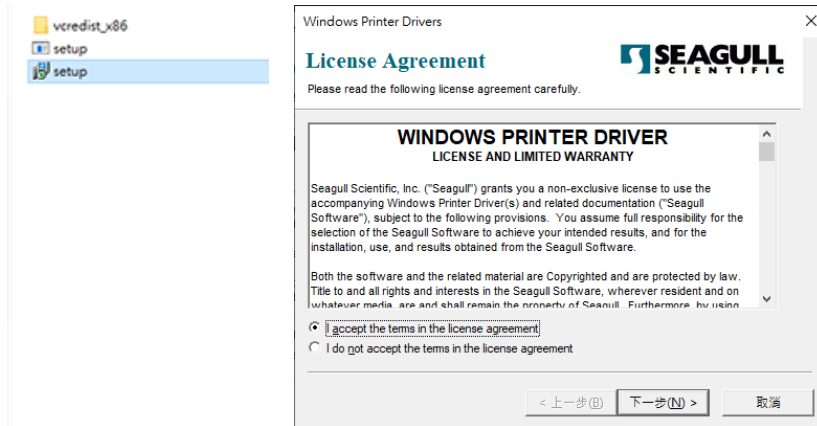

Step2. Select the path to unzip and click "Next"

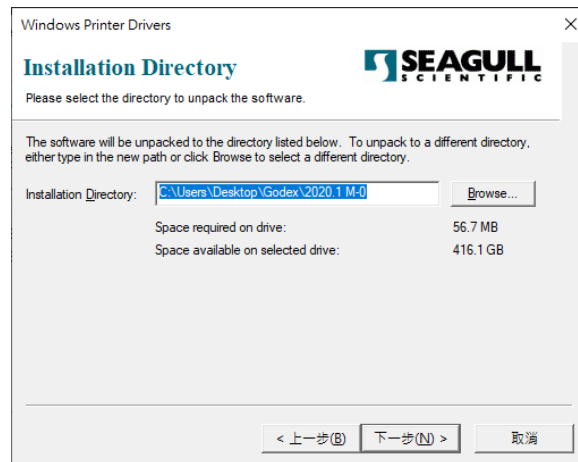

Step3. Click "Finish" and open the Driver Wizard

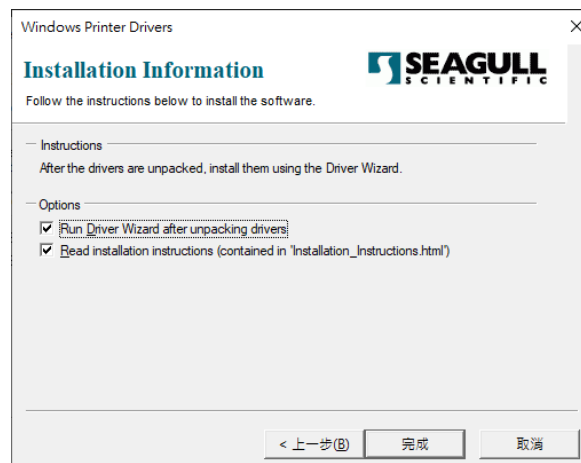

Step4. The driver installation wizard will automatically detect the model, please click "Next" to start the installation.

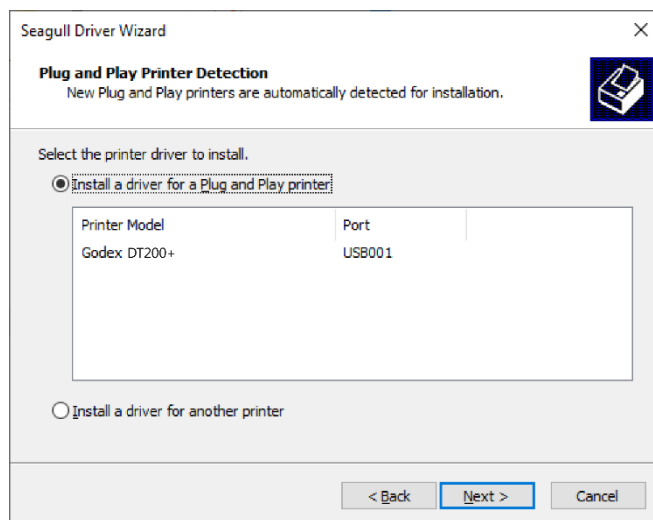

Step5. After entering the printer name, click "Next"

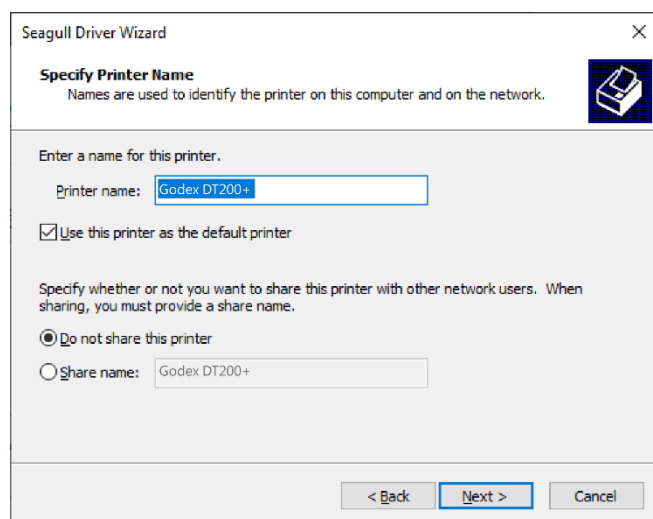

Step6. After confirming the settings, click "Finish" to install.

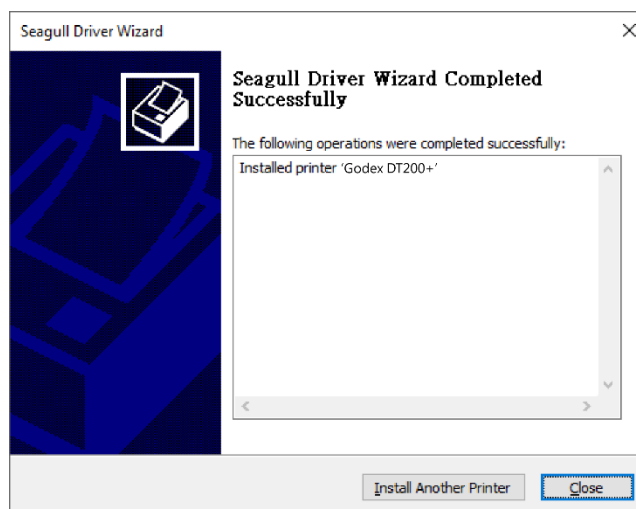
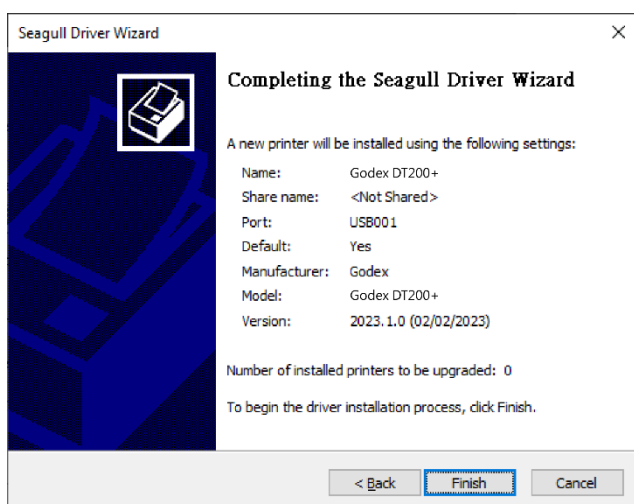

Installing GoLabel II

Step1. Click the installer in the folder to install.

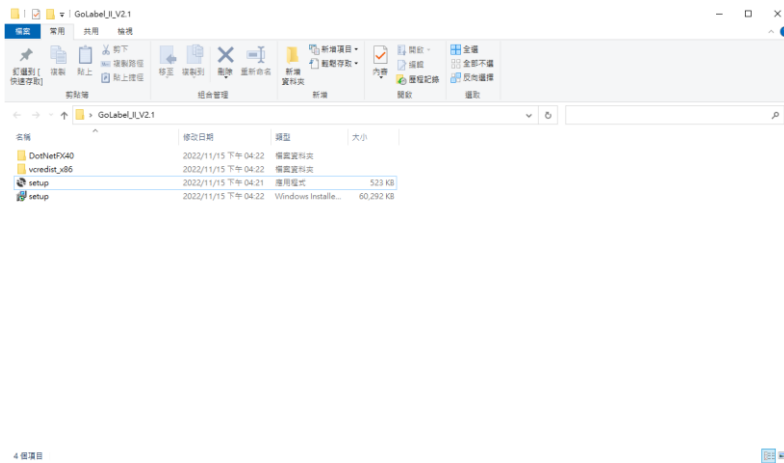

Step2. After entering the installation screen, click “Next”.

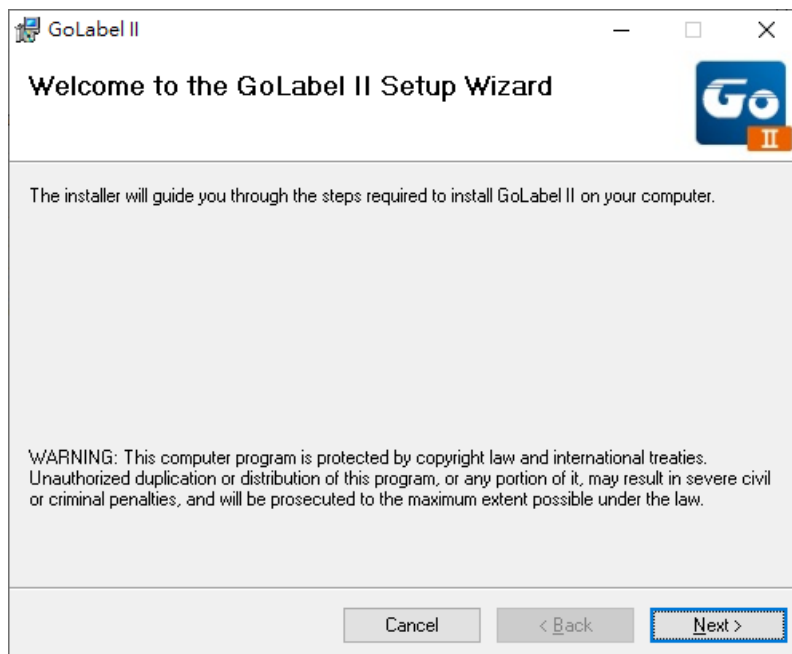

Step3. After selecting the folder to install, click “Next”

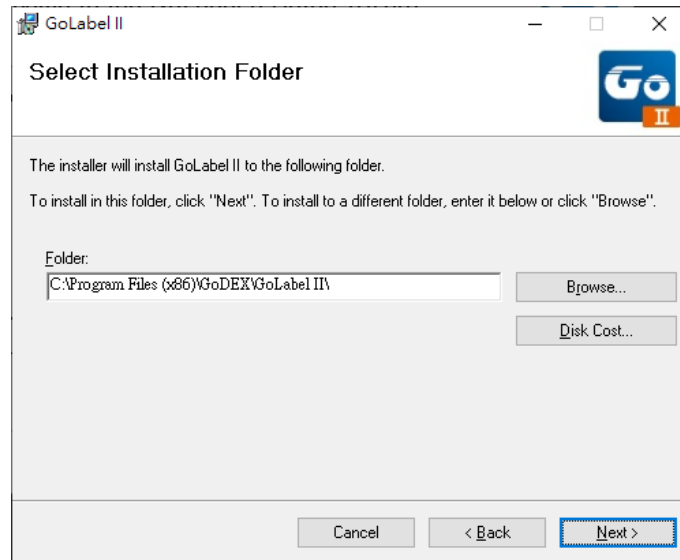

Step4. Click Next to start the installation.

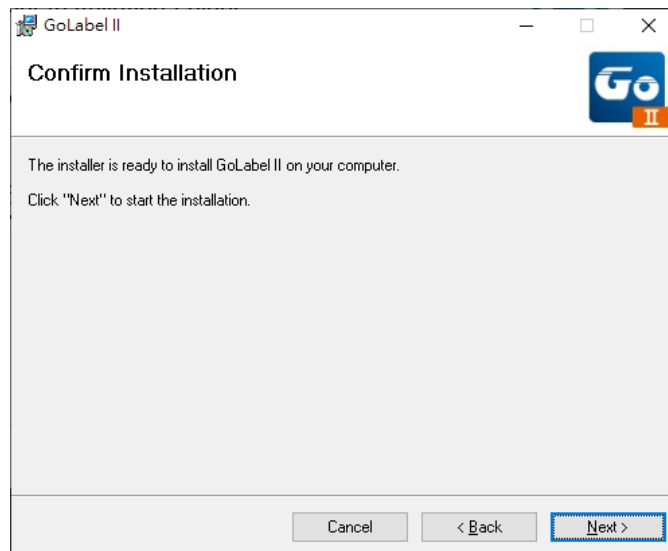

Step5. Finish installation

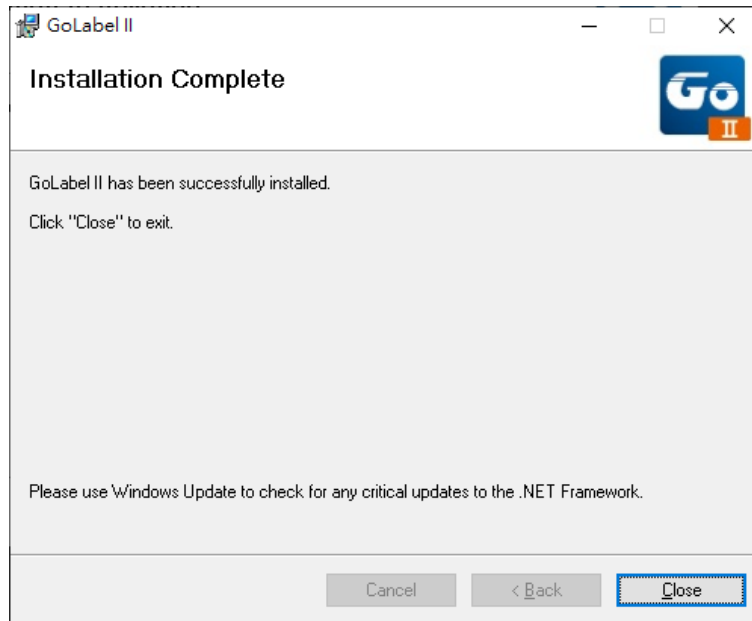

3 Printer Setting and Control

3.1 Operation Panel Introduction

POWER Button

Press the POWER button and the LED indicator lights up green. The printer is on “ Ready to print “ status now. When printer is turned on, keep pressing the POWER button for 3 seconds will turn the printer off.

FEED Button

When you press the FEED button, the printer moves the label to the defined stop position.

If you are using continuous labels, pressing the FEED button will move label stock until you release the button again.

If you are using individual labels, pressing the FEED button will move only one label.

PAUSE PRINTING_FEED Button

Pressing the FEED button during printing will interrupt printing. When the PFEED button is pressed again, the printer resumes printing. Example: While a 10-label print job is running, you press the FEED button to pause the printer.

Two of the labels have been printed. To resume printing and print the remaining eight labels, you press the FEED button again.

CANCEL PRINTING_FEED Button

Pressing the FEED button over 3 seconds during printing cancels a print job. The current print job is cancelled.

Example: While a 10-label print job is running, you press the FEED button. Two of the labels have been printed. The print job is cancelled and the remaining eight labels are not printed.

3.2 LED Status (DT200+/DT200L+ Series)

Press the FEED button and keep it pressed, then switch on the printer. You will hear two beeps and the LED lights up red.

Release the FEED button. The printer will now automatically measure the label size and then print a test page

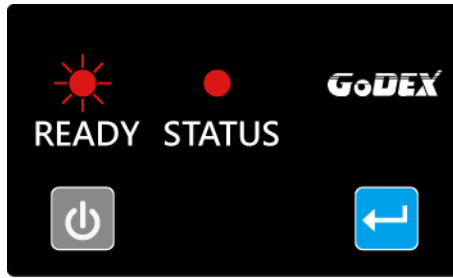

LED Indicator	READY	STATUS
		Red flashing

The contents of a self-test printout are listed below.

	DT200i+ V4.001v
	USB S/N:12345678
	Serial port:96,N,8,1
Model & F/W Version	MAC Addr:xx-xx-xx-xx-xx-xx
USB ID setting	Gateway xxx.xxx.xxx.xxx
Serial port setting	Sub-Mask xxx.xxx.xxx.xxx
MAC address of Ethernet port	Card Status: HW Unable to detect any card [02]
Gateway setting	Network: LAN OFF-LINE
Netmask setting	PORT Status L S E U B
Wireless transmission device	1 1 1 1 1
Network status	#####
Port status	0000 FORM(S) IN MEMORY
	0000 GRAPHIC(S) IN MEMORY
	000 FONT(S) IN MEMORY
Number of forms	000 ASIAN FONT(S) IN MEMORY
Number of graphics	000 DATABASE(S) IN MEMORY
Number of fonts	000 TTF(S) IN MEMORY
Number of Asian fonts	65258 KB FREE MEMORY
Number of databases	^S4 ^H8 ^R000 ~R255 ~Q+0
Number of scalable fonts	^W100 ^Q149,3 ^E15
Free memory size	Option:^D0 ^O0 ^AT
Speed, Density, Ref. Point, Print direction	See. : 0.4 1.3 0.9 [0.9_0]
Label width, Form length, Stop position	Code Page:850
Cutter, Label dispenser, Mode	
Sensor setting	
Code page	



3.3 Error Alerts

In the event of a problem that prevents normal functioning of the printer, you will see an error message on LED indicators and hear some beep signals. Please refer to below table for the error alerts.





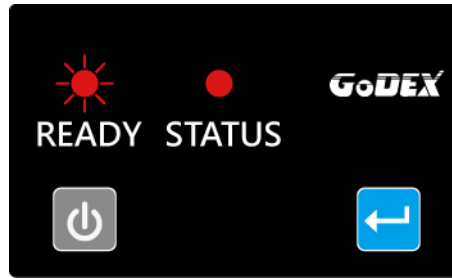

Error Light

● Red 

Flashing Frequency

● Flashing 
● Light on 



READY LED	STATUS LED	Type	Beeps	Description	Solution
		Print Head Error	2*4 beeps	The printing mechanism is not correctly closed.	Open the print mechanism and close it again.
		Print Head Error	None	High temperature at the print head.	Once the print head has cooled down, the printer switches to standby mode.
		Media Error	2*3 beeps	No need ribbon installed and printer Display error.	Make sure that the printer is set to direct thermal printing mode.
		Media Error	2*2 beeps	No paper is detected.	Make sure that the label sensor is positioned correctly. If the sensor still does not detect the paper, run the auto-detection function again.
	Paper is finished.			Replace the label roll.	
	Printer feed problem.			Possible reasons: the print medium has become trapped around the rubber roll; the sensor cannot detect a gap or black mark between the labels; there is no paper. Please reset the sensor.	
		File Error	2*2 beeps	The memory is full. The printer prints the message "File System full".	Delete unnecessary data or install additional memory.
	Unable to find file. The printer prints the message "File Name Not Found".			Use the "~X4" command to print all files. Then check whether the files exist and whether the names are correct.	
	A file of the same name already exists. The printer prints the message "Duplicate Name".			Change the name of the file and try storing it again.	

3.4 LCD Interface Introduction(DT200i+/DT200iL+ Series)

Getting Started

Press the POWER button to turn on the printer, and the START UP SCREEN appears.

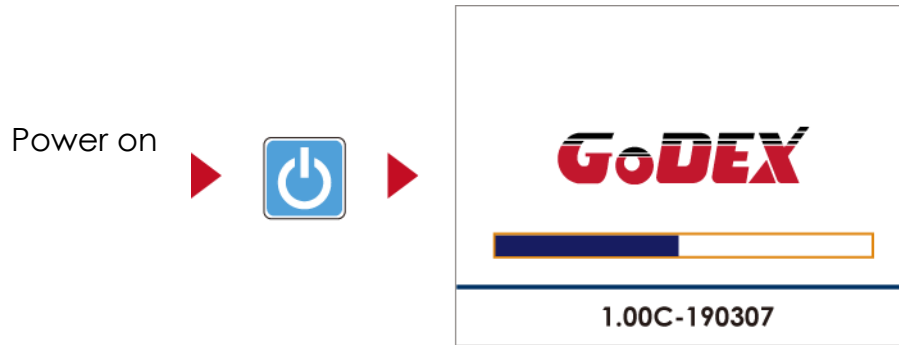

If the printer is on “ready to print” status, the LCD screen should display the message “Ready” on the screen.



Please keep pressing → button and wait for the timer to be filled, then the LCD interface will enter into the MAIN PAGE for SETTING MODE. You can make various setting functions in SETTING MODE.

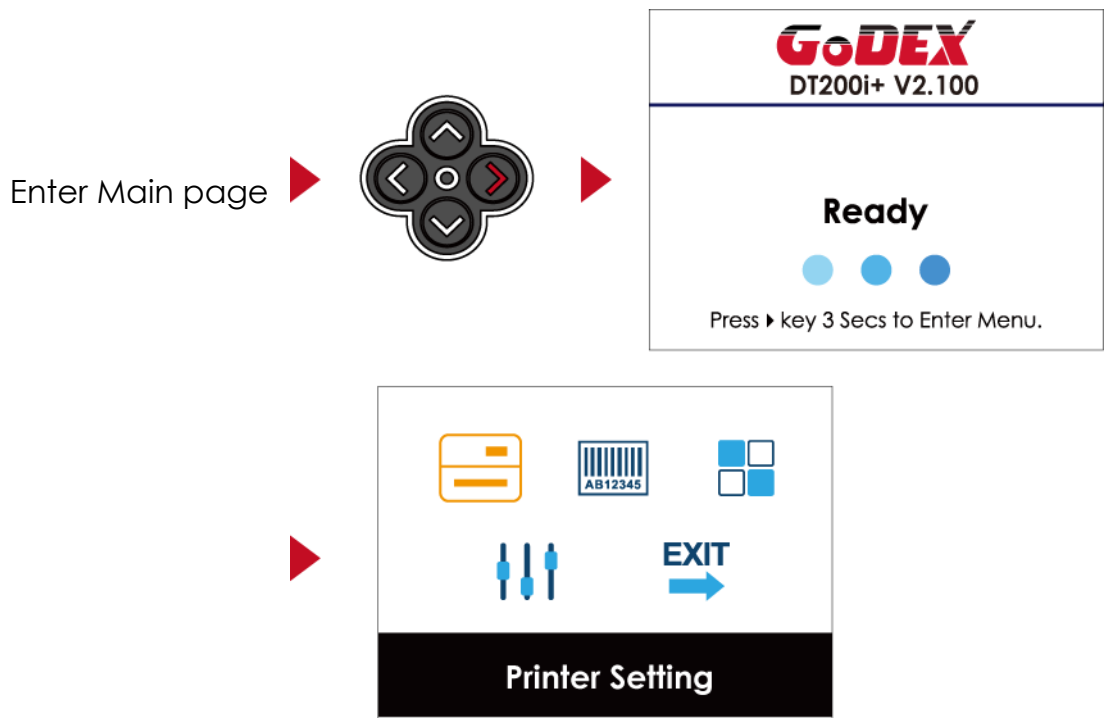

Operations on Setting Page

On MAIN PAGE, press → or ← button to move the cursor and select the functions.

Select a designated function and press FEED button, you will enter the SETTING PAGES for the function.

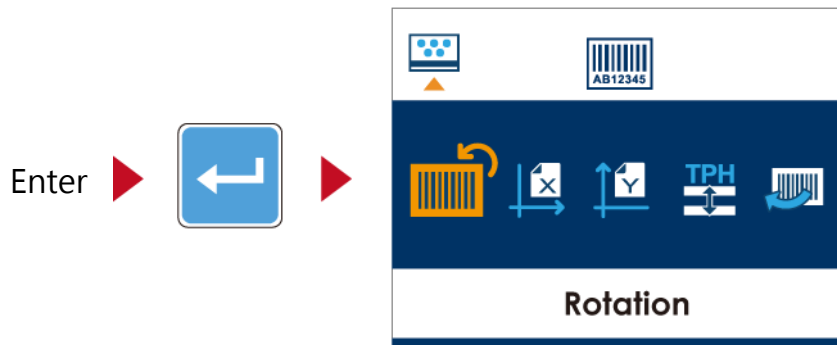
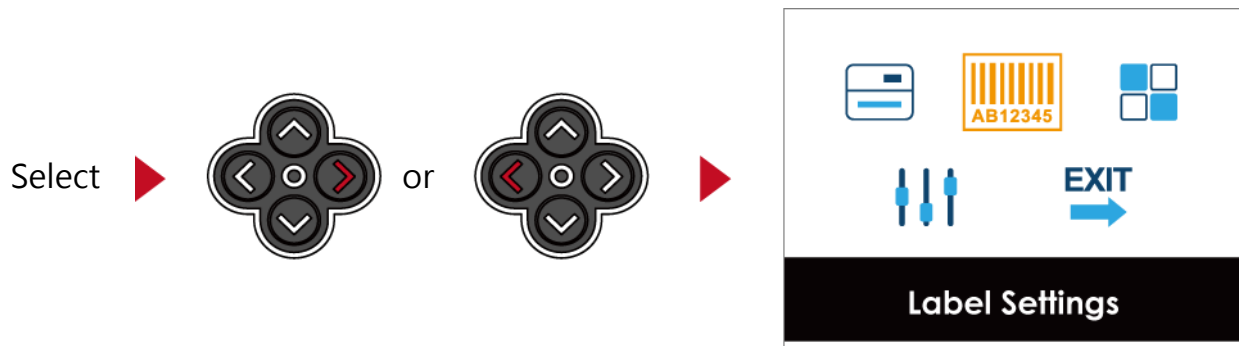

On SETTING PAGES, press → or ← button to select the setting items.

Select a designated function and press FEED button, you will enter the SETTING VALUE PAGES for the function.

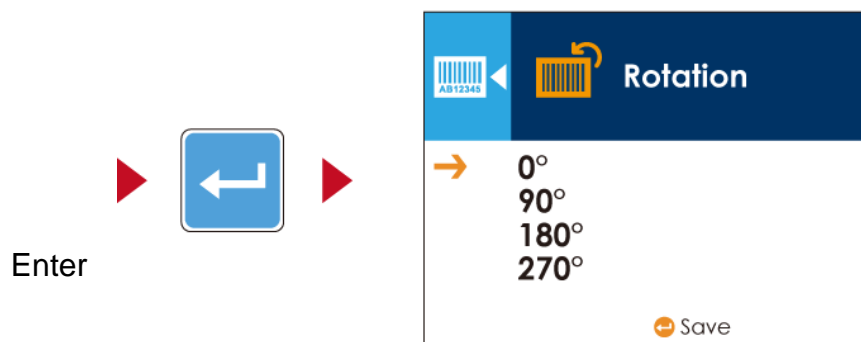
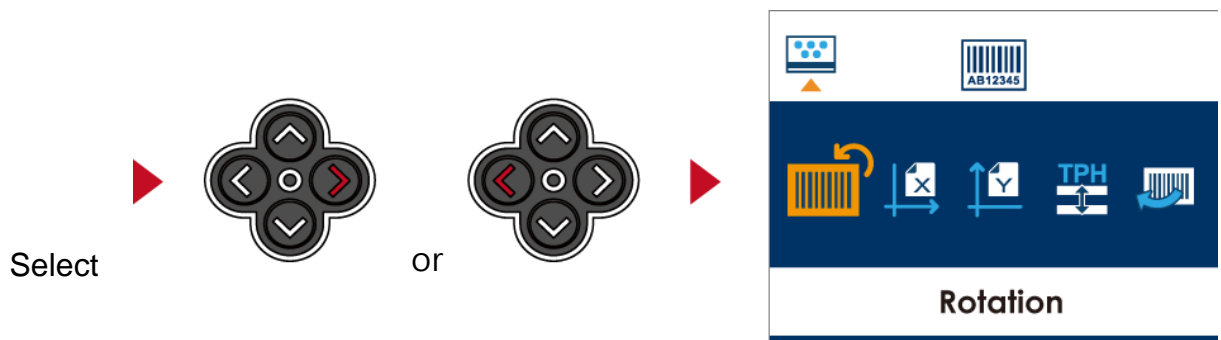

On SETTING VALUE PAGES, press ↑ or ↓ button to change the setting values.

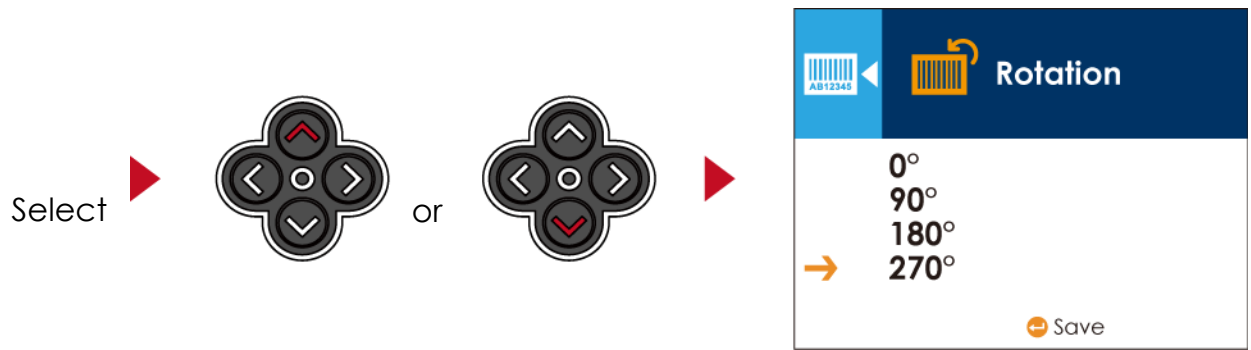

Press FEED button will apply the setting value you just selected, and the red tick will appear to mark the value.

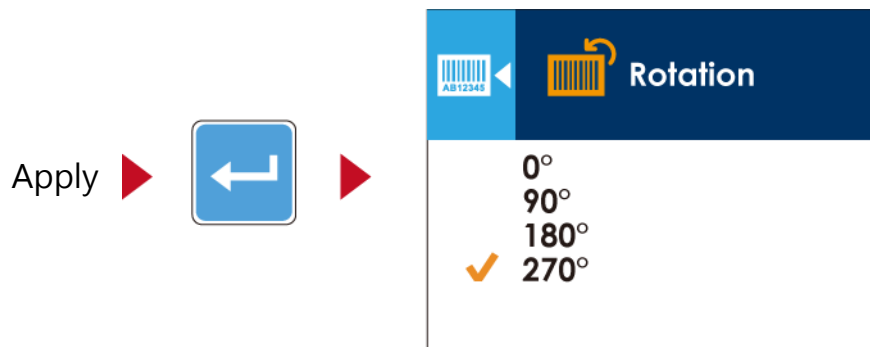

Notice

- The arrow indicates the value you are selected. →
- The tick indicates that the selected value is applied now. ✓

Exit from Current Page to Ready Status

The icon on top-left corner displays the capture of upper level screen and also guides you back to upper level with left or up arrow.

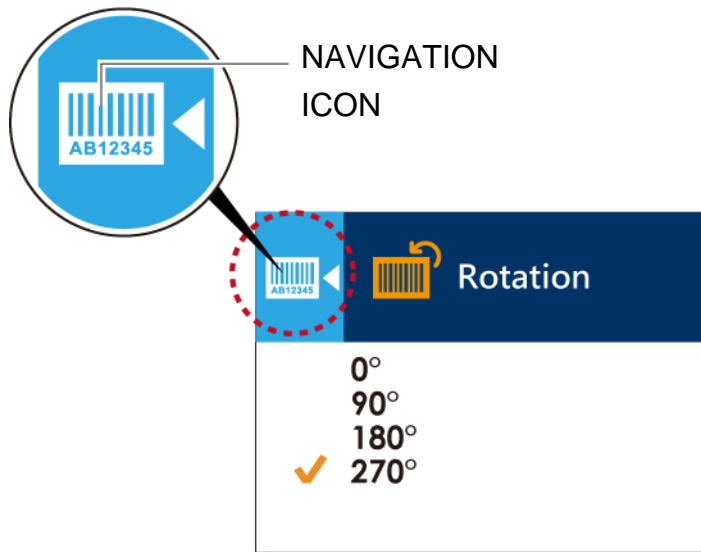

On SETTING VALUE PAGES, press ← button will go back to the upper level screen.

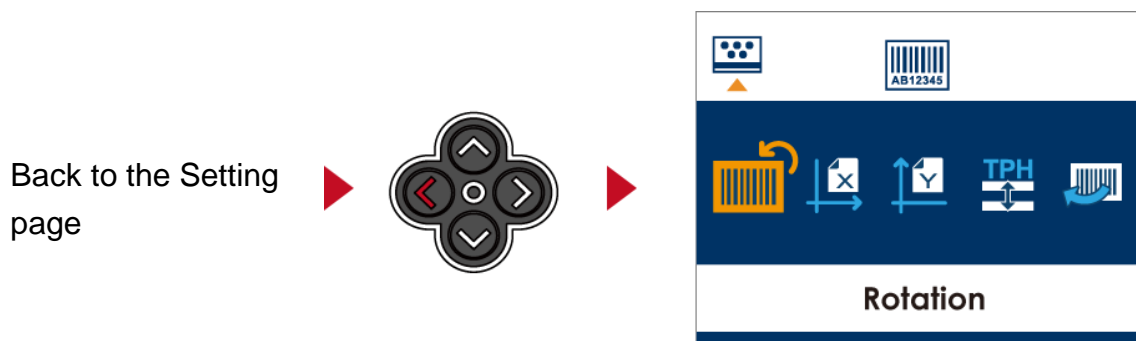

On SETTING PAGES, press ↑ button will go back to the MAIN PAGE screen.

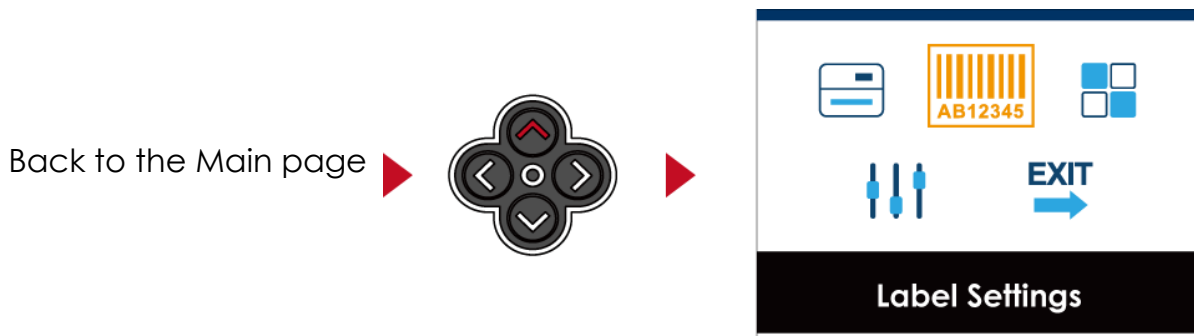

On MAIN PAGE, select the "EXIT" icon and press the FEED button to exit from SETTING MODE and the printer goes back to READY status.

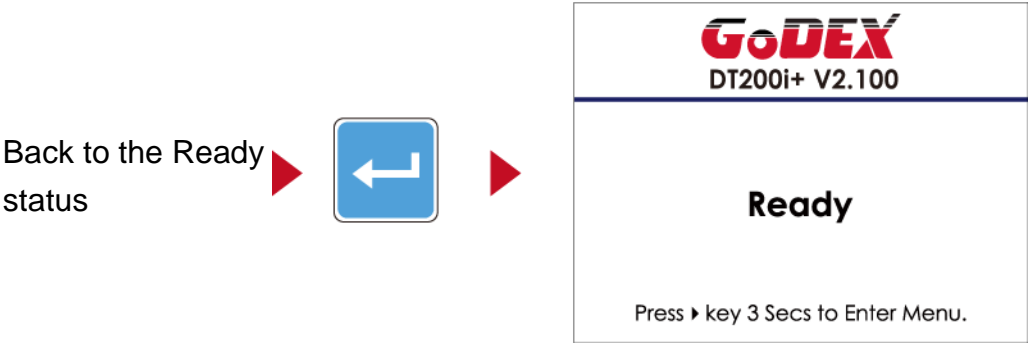

3.5 LAN Setting(DT200i+/DT200iL+ Series)

Operations on Setting Page

On MAIN PAGE · press → or ← button to move the cursor and select the functions.

Select a designated function and press FEED button, you will enter the SETTING PAGES for the function

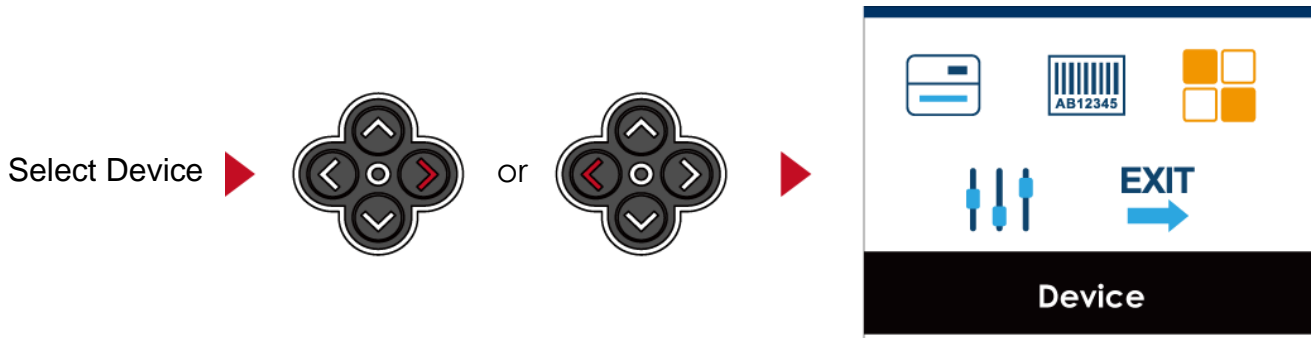

On LAN Setting PAGE · press → or ← button to select the setting items.



Select DHCP and press FEED button, you will be able to setup DHCP function

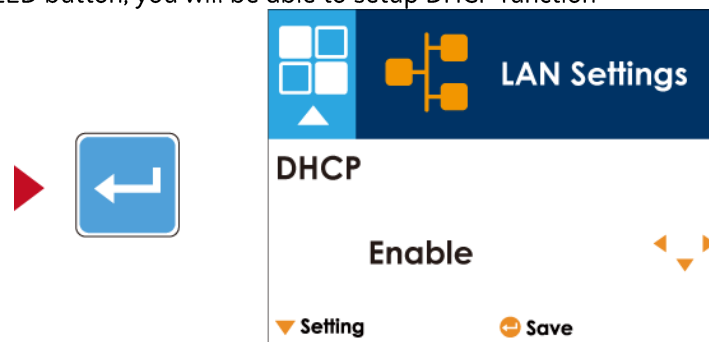

The default of DHCP is Disable. Press ↑ or ↓ button to change the setting values

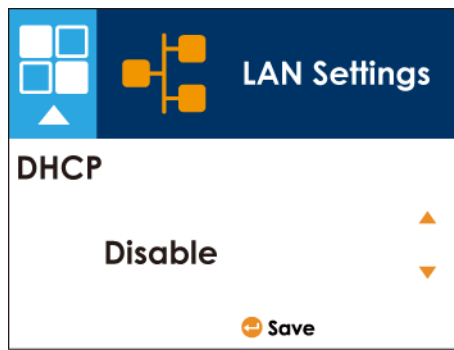

Select ↓ to enable DHCP

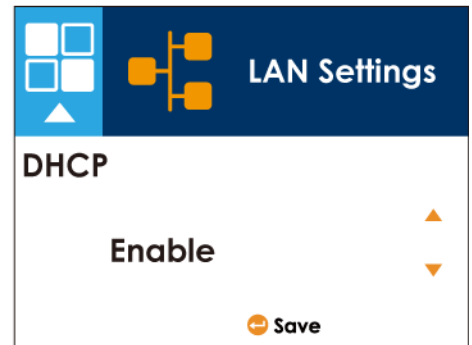

Press FEED button twice to save the setting.

Press FEED once to exit.

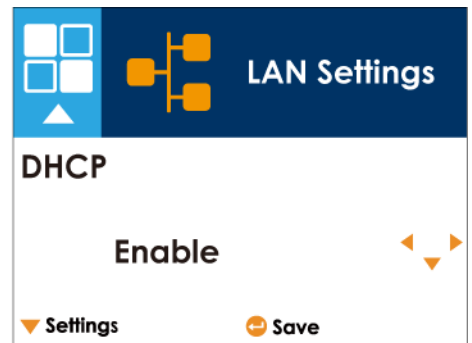

Press FEED again to save and return to previous SETTING PAGE

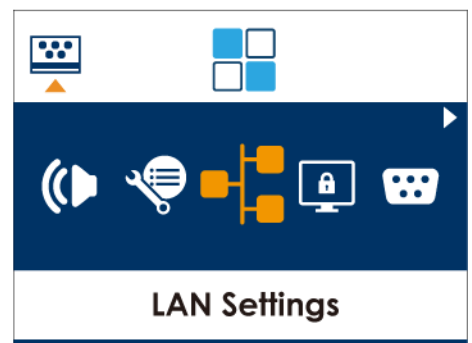

3.6 LCD Password (DT200i+/DT200iL+ Series)

Operations on Setting Page

On MAIN PAGE, press → or ← button to move the cursor and select the functions. Select a designated function and press FEED button, you will enter the SETTING PAGE for the function.

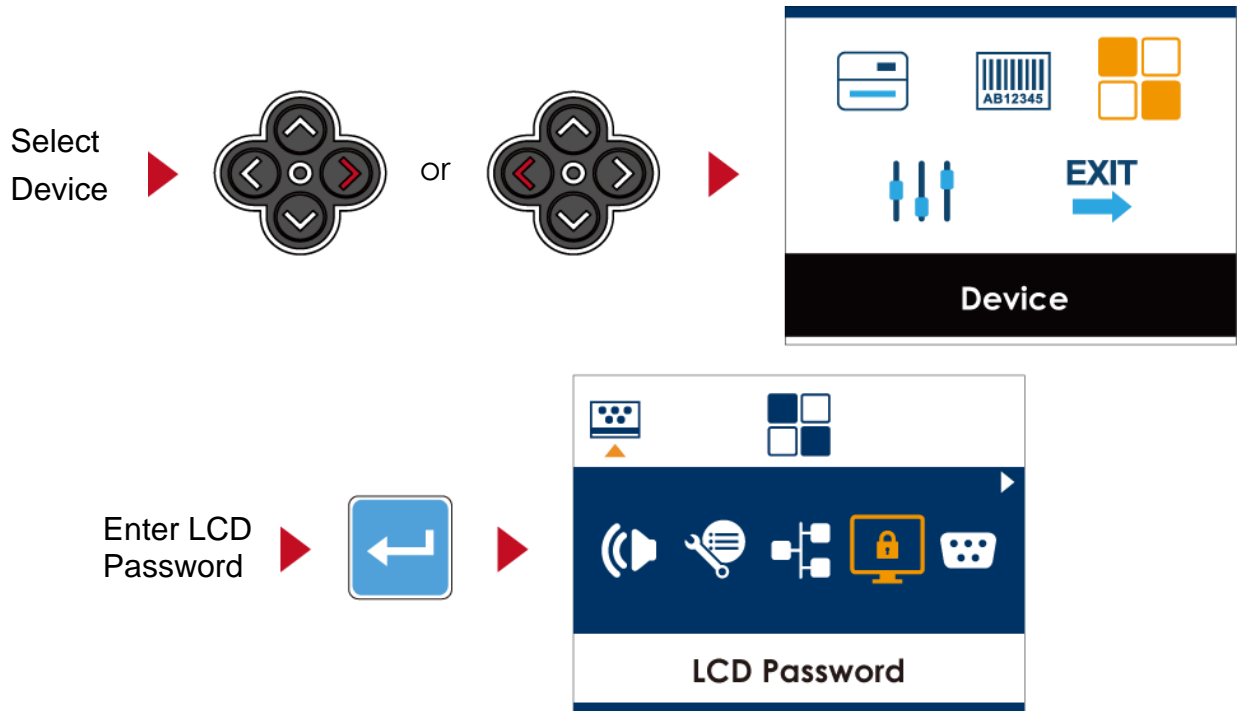

The default of LCD Setting is Disable. Press ↑ or ↓ button to change the setting values.

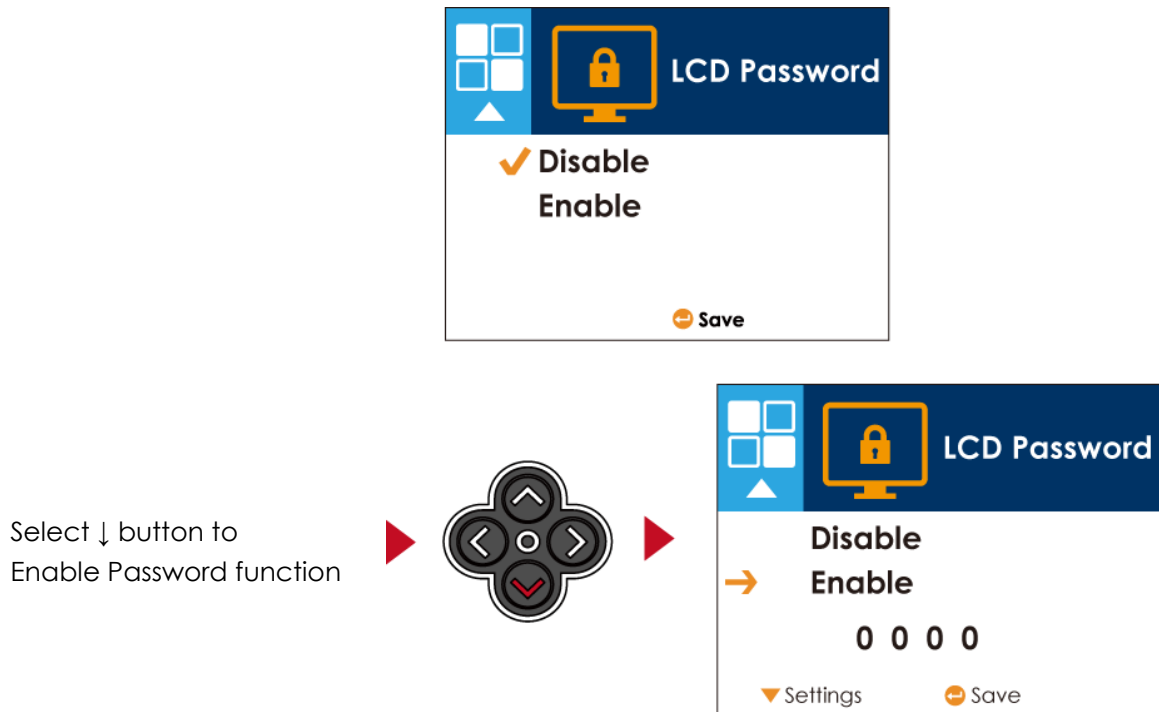

Select ↓ button again to setup the password

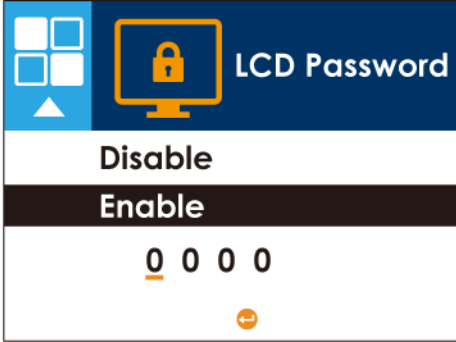

Press FEED button twice to save the setting.

Press FEED button once to exit.

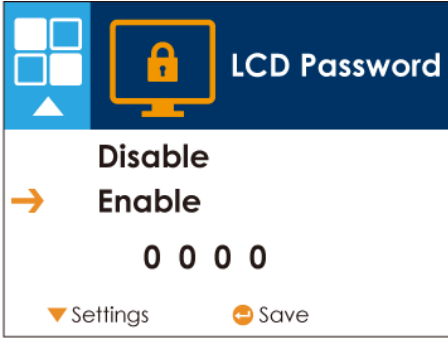

Press FEED button again to save and return to previous SETTING PAGE



3.7 LCD Interface Function(DT200i+/DT200iL+ Series)

Main Page

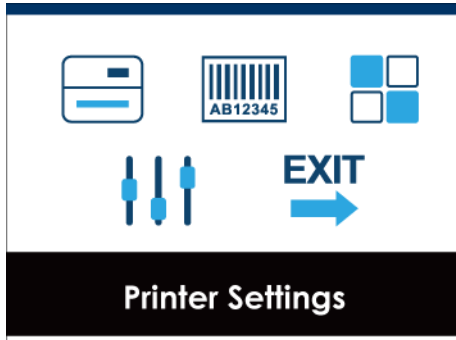

Printer Setting

Setting items for printer, ex. Printing speed, darkness.
Also includes a Printing Wizard for your ease of printing.



Label Setting

Setting items for printing label, ex. Rotation, Printing position offset.



Device

Option modules and connection port settings



Analysis



Self-Diagnose functions for printer, ex. TPH testing, self-test page printing.





Exit

Exit from Setting Mode.

Setting Items in Setting Mode

 <p>Printer Setting</p>	LCD Language		English	
			German	
			繁體中文	
			简体中文	
	Wizard	Speed	2-7	
		Darkness	0-19	
		Media Type	Label with gaps	
			Label with marks	
			Continuous	
		Printer Mode	Direct Thermal	
	Thermal Transfer			
	Tear-off Position	0-40		
	Setting	Darkness	0-19	
		Speed	2-7	
		Sensor	Media Detection	Auto Select
				See-Through
				Reflective
			Media Type	Label with gaps
				Label with marks
				Continuous
		Printing Mode	Direct Thermal	
Thermal Transfer				
Tear-off Position		0-40		
Top of Form		Apply		
		Cancel		
Codepage	850			
	852			
	437			
	860			
	863			
	865			
	857			
	861			
	862			
	855			
	866			
	737			
	851			
	869			
	Win 1252			
Win 1250				
Win 1251				
Win 1253				
Win 1254				
Win 1255				
Win 1257				
 <p>Label Setting</p>	Rotation		0°	
			90°	
			180°	
			270°	
	Horizontal offset	-100 – 100		
	Vertical offset	-100 – 100		
Start offset	-100 – 100			

	Recall Label		001 Form Name
			002 Form Name
	Buzzer		Apply
			Cancel
	Optional Setting	Option	None
			Cutter
			Label Dispenser
		Pre-Printing	Applicator
			Apply
			Cancel
	LAN Setting	Port No.	09100
		DHCP	Disable
			Enable
		Default Gateway	192.168.000.254
		Dynamic IP	192.168.102.076
		Subnet Mask	255.255.255.000
	LCD Password		Disable
			Enable
	Serial Port Setting	Baud Rate	4800 bps
			9600 bps
			19200 bps
			38400 bps
			57600 bps
			115200 bps
		Parity	Non
			Odd
			Even
		Data bits	7 bits
		8 bits	
	Stop bits	1 bits	
		2 bits	
	RTC Setting	Clock display	Apply
			Cancel
		RTC Setting	YYYY/MM/DD
HH:MM:SS			
Bluetooth Setting	Clear Bind	Enable	
		Disable	
	Make Device Visible	Enable	
		Disable	
	SSP	Enable	
		Disable	
PIN Code	0000		
	Search Device		
 Analysis	Calibration		Apply
			Cancel
	Self-test		Apply
			Cancel
	TPH Testing		Apply
			Cancel
	Reset to Default		Apply
			Cancel
	Clear Memory	Label Format	Apply
			Cancel
		Graphic	Apply
			Cancel
		Bitmap Fonts	Apply
			Cancel
True Type Fonts		Apply	
	Cancel		
Asian Fonts	Apply		
	Cancel		
	ALL	Apply	

			Cancel
EXIT  Exit	Exit		





3.8 Status of LCD Interface (DT200i+/DT200iL+ Series)

When printer is on standby status (ready to print), the LCD interface will display “Ready” on screen. You can only print on this “Ready” status.

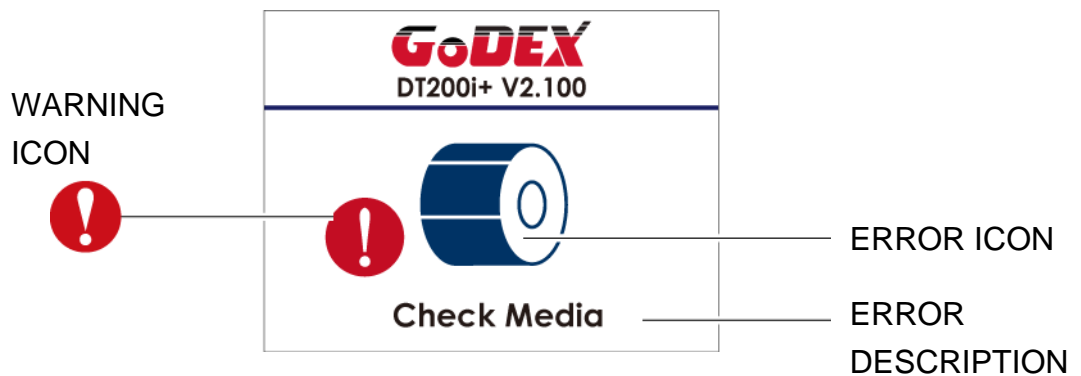

If there is any printers error, the LCD screen will display the error screen to show the type of error. You can fix the error according to the notice.







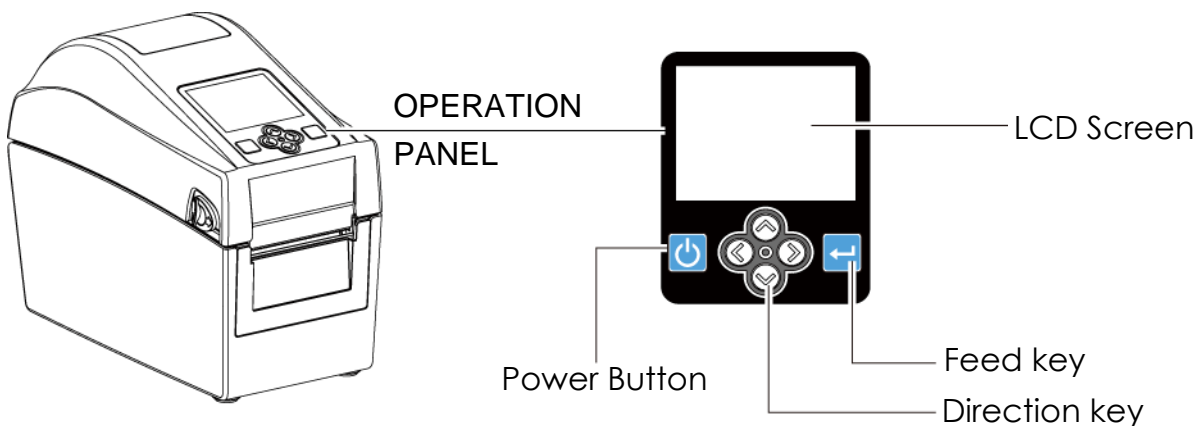

	To upper level	Appears on the NAVIGATION ICON of Setting Pages. It guides you back to upper level by pressing “LEFT” key.
	To upper level	Appears on the NAVIGATION ICON of Setting Value Pages. It guides you back to upper level by pressing “UP” key
	Lock	On Setting Value pages, press “RIGTH” key to lock the value for preventing unexpected change.
	Unlock	For locked value, press “RIGHT” key again to unlock the value.
	Scroll the value	On Setting Value pages, press “UP” or “DOWN” key to scroll the values for your selection.

3.9 Error Alerts (DT200i+/DT200iL+ Series)

In the event of a problem that prevents normal functioning of the printer, you will see an error message on LCD screen and hear some beep signals. Please refer to below table for the error alerts.



Operation Panel Status	Type	Beeps	Description	Solution
 <p>THP opened</p>	Print head Error	2 x 4 beeps	The printing mechanism is not correctly closed.	Open the print mechanism and close it again.
 <p>TPH overheat</p>	Print head Error	None	High temperature at the print head.	Once the print head has cooled down, the printer switches to standby mode.
 <p>Check ribbon setting</p>	Media Error	2 x 3 beeps	No ribbon is installed and the printer displays an error.	Make sure that the printer is set to direct thermal printing mode.
 <p>Check paper setting</p>	Media Error	2 x 2 beeps	No paper is detected.	Make sure that the label sensor is positioned correctly. If the sensor still does not detect the paper, run the auto-detection function again.
			No paper is detected.	Replace the label roll.
			No paper is detected.	Possible reasons: the print medium has become trapped around the rubber roll; the sensor cannot detect a gap or black mark between the labels; there is no paper. Please reset the sensor.

Operation Panel Status	Type	Beeps	Description	Solution
 <p>Memory full</p>	File Error	2 x 2 beeps	The memory is full. The printer prints the message "File System full".	Delete unnecessary data or install additional memory.
 <p>File name can't be found</p>			Unable to find file. The printer prints the message "File Name not found"	Use the "~X4" command to print all files. Then check whether the files exist and whether the names are correct.
 <p>File name duplicated</p>			A file of the same name already exists. The printer prints the message "Duplicate Name".	Change the name of the file and try storing it again.

3.10 USB Host

Definition : USB Host port supports either device : USB memory stick, keyboard or scanner.

Purpose

USB memory stick : It extends the user memory space up to 32GB for Graphic, Font, Label Format, DBF and Command files downloading. The printer's Firmware also can be updating if copy new version of Firmware into USB memory stick.

Connecting an USB keyboard to printer for " Standalone" mode operation.

Plug-in an USB scanner to operate the printer in "Standalone" mode.

Usage of Extended Memory

USB memory stick : It supports hot-plugging function; printer will create a Folder "\LABELDIR" and switch "User Flash to " Extended Memory" automatically while user plugs an USB memory stick into a GoDEX "i" model printer.

Connect the USB Stick plugged -in printer to PC via USB Device or Ethernet port and run "GoLabel" software to download Graphic, Font, Label Format, DBF and Command files to the printer.

Detail download procedures, please refer to "GoLabel On-line Help".

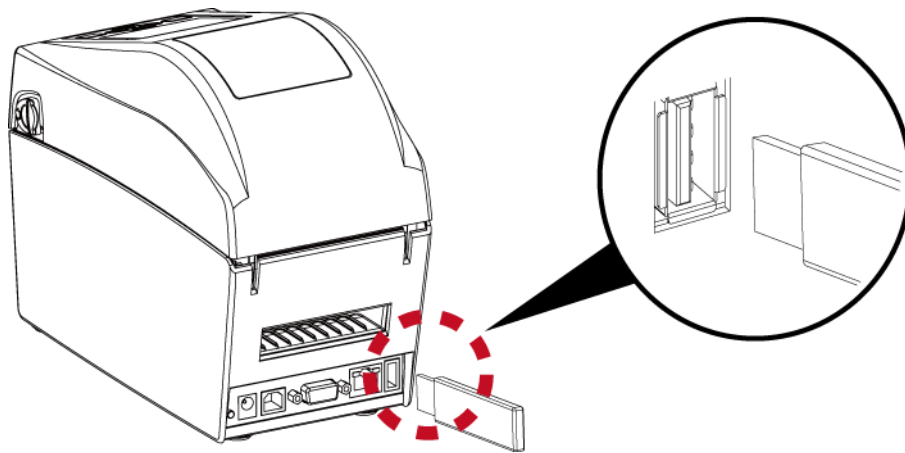

Usage of Firmware Update

Remove USB memory stick from printer and plug-in it to a PC's USB port; delete Firmware "*.bin" file from "\LABELDIR\FW" of USB memory stick if it existing; or create a Folder "\LABELDIR\FW" to USB memory stick if it doesn't existing.

Copy a new version of Firmware "xxxx.bin" to the Folder "\LABELDIR\FW"; and then remove USB and plug-in back to the printer that going to update Firmware.

The printer will update the Firmware automatically when plug-it-into the printer and printer find-out the Firmware in "\LABELDIR\FW" is newer version.

Don't remove the USB memory stick out while it's under updating with "Flash Writing..." message that displays on LCD panel.

USB Keyboard

When plug-in an USB keyboard to the printer, LCD panel will display “Standalone Mode”, press the “Enter” key on keyboard and “Feed” key in the printer to entering to the dialog for “Recall Label” operation.

Only the sub-dialog “Recall Label” is able operating by keyboard as follow definition:

1. Press “ESC” key to exist from “Standalone Mode” or back to previous dialog
2. Press “F1”, it will let the printer from “Ready” mode entering into “Standalone Mode”
3. Press “Enter”, “Arrow” and “Alphabetic” keys as the usual in PC that will perform the key-in function of “Recall Label” in “Standalone Mode”.

Scanner

When plug-in an USB scanner to the printer, LCD panel will display “Standalone Mode”, press the “Feed” key in the printer to entering the dialog of “Recall Label” operation. User performs the “Recall Label” function interactively through the LCD panel, 4 direction keys, Feed key and Scanner.

Scanner is using in “standalone Mode” to scanning the “Serial Number, Variable” and Print Quantity while the printer prompts a message on LCD panel and wait for data input.

4. NetSetting for Ethernet

4.1 Installing the NetSetting software

The NetSetting software is used to manage the network configurations when connecting the printer via Ethernet port.

It is available on product CD or can be downloaded from official website. To install the NetSetting, please follow below steps.

1. Select the icon for the NetSetting installation file and click it to start the installation.

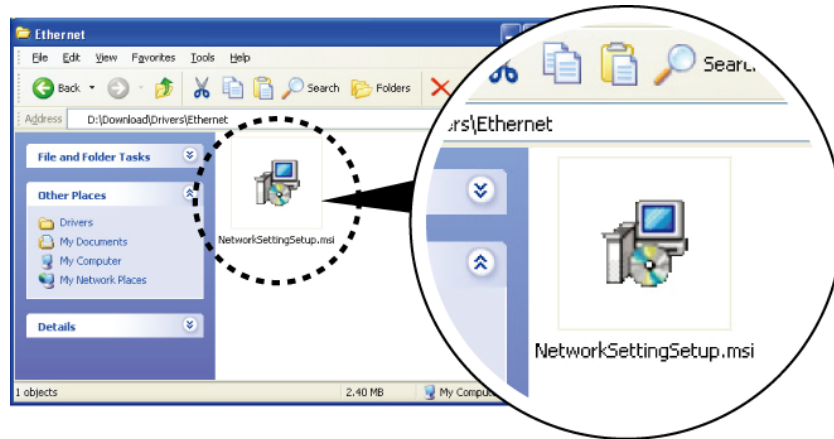

2. Follow the instructions on the screen. The Setup Wizard guides you through the installation procedure.
3. Specify the "Installation Folder".

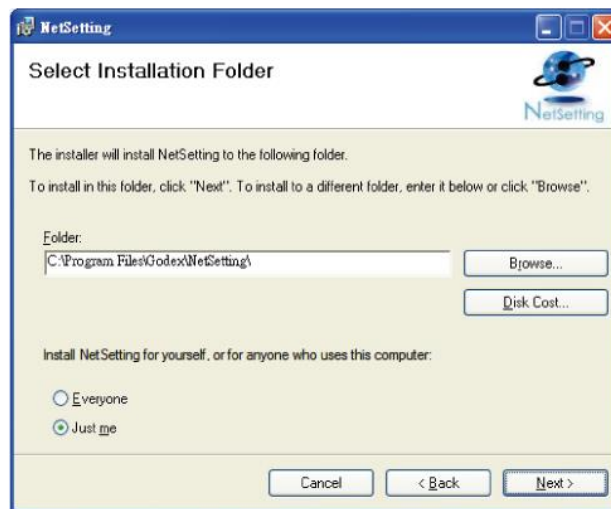

4. Click "Next" to start the installation.
5. Once the installation is completed; you will see the NetSetting icon on your desktop.



4.2 The Interface of NetSetting

Click the NetSetting icon to start the program; you will see the start page as below. The start page will display the basic information of connected printer and your PC.

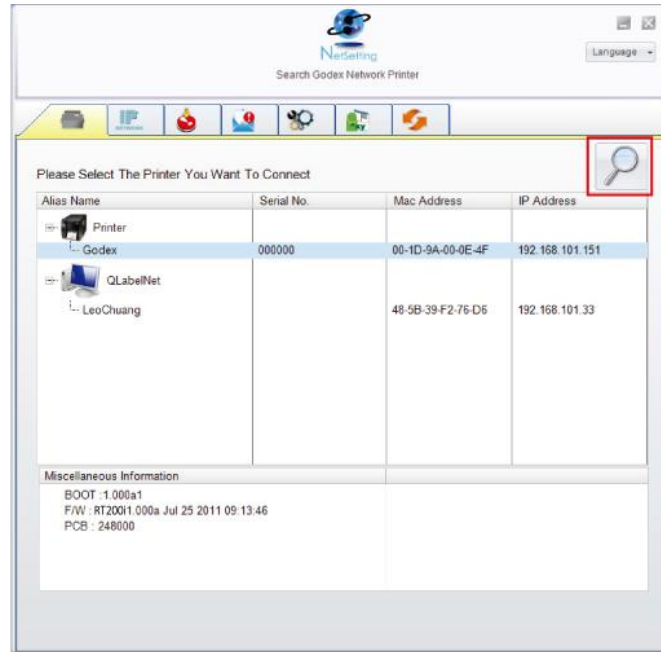

Click the magnifier icon to search the Godex printers which are connected via Ethernet port in your network environment. Once a connected Godex printer is detected, it will be listed on the start page.

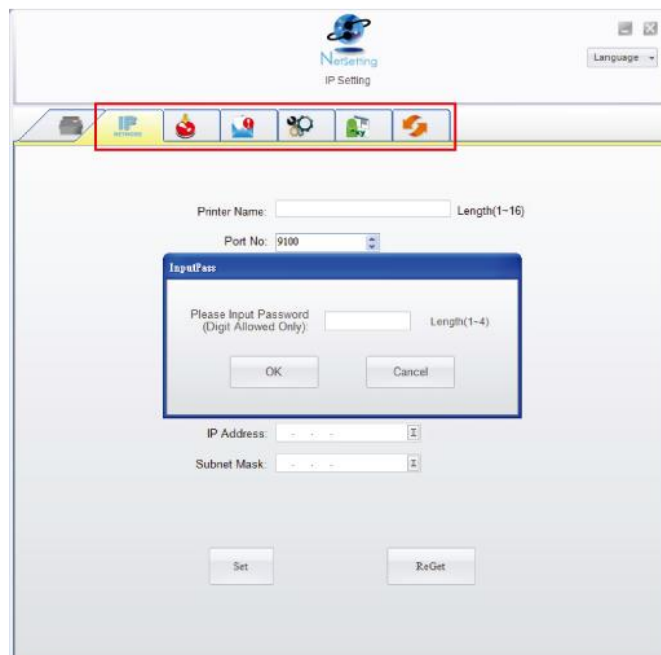

There are six tabs on the top of interface which can configure different types of network settings. But for the data security reason, you need correct password to enter the configuration pages.

Notice The default password is "1111", you can change the password later from the "IP Setting" tab.

IP Setting

The IP Setting tab can change the printer name, Port number, Gateway setting and the password for configuring the printer. You can also set the printer's IP address either by DHCP or by Static IP.

The screenshot shows the 'NetSetting IP Setting' window. The title bar includes the 'NetSetting IP Setting' logo and a 'Language' dropdown menu. The main content area is divided into several sections:

- Printer Name:** A text input field containing 'Godex' with a length indicator of 'Length(1~16)'.
- Port No.:** A dropdown menu showing '9100'.
- Default Gateway:** A text input field containing '192 . 168 . 0 . 254' with a small 'I' icon to its right.
- Password:** A text input field containing '0000' with a length indicator of 'Length(1~4)'.
- IP Configuration:** Two radio buttons are present: 'Get IP From DHCP Server' (which is selected) and 'Static IP'.
- Static IP Fields:** Below the radio buttons, there are two text input fields: 'IP Address' containing '192 . 168 . 101 . 151' and 'Subnet Mask' containing '255 . 255 . 255 . 0', both with small 'I' icons to their right.
- Buttons:** At the bottom of the window, there are two buttons: 'Set' and 'ReGet'.

You can press "Set" button to apply the settings and "ReGet" button to refresh the setting values.

Notice To fully benefit from the NetSetting software, you should be familiar with basic networking principles. Please contact your network administrator for related network setting information.

Alert Path Setting

NetSetting will send the alert messages to designated mail account when the error happened on printer. The alert messages are sent by SMTP (Simple Mail Transfer Protocol) or SNMP (Simple Network Management Protocol).

You can set or change the configurations of SMTP and SNMP on this “Alert Path Setting” tab.

SMTP Notification Enable

Login Account: Length(1~64)

Login Password: Length(1~16)

Server IP Address: xxx.xxx.xxx.xxx

Mail Subject: Length(1~60)

Mail From Address: Length(1~32)

Mail To Address: Length(1~32)

Duration Cycle: 0 ~ 168 Hours

Event Counter: 1 ~ 100

SNMP Notification Enable

SNMP Community: Length(1~16)

SNMP Trap Community: Length(1~16)

Trap IP Address: xxx.xxx.xxx.xxx

You can press “Set” button to apply the settings and “ReGet” button to refresh the setting values.

Alert Message Setting

For the alert message notification function, you can decide which error cases need to be sent out to the operator. Moreover, the alert messages can be set to be sent by SMTP, SNMP or both.

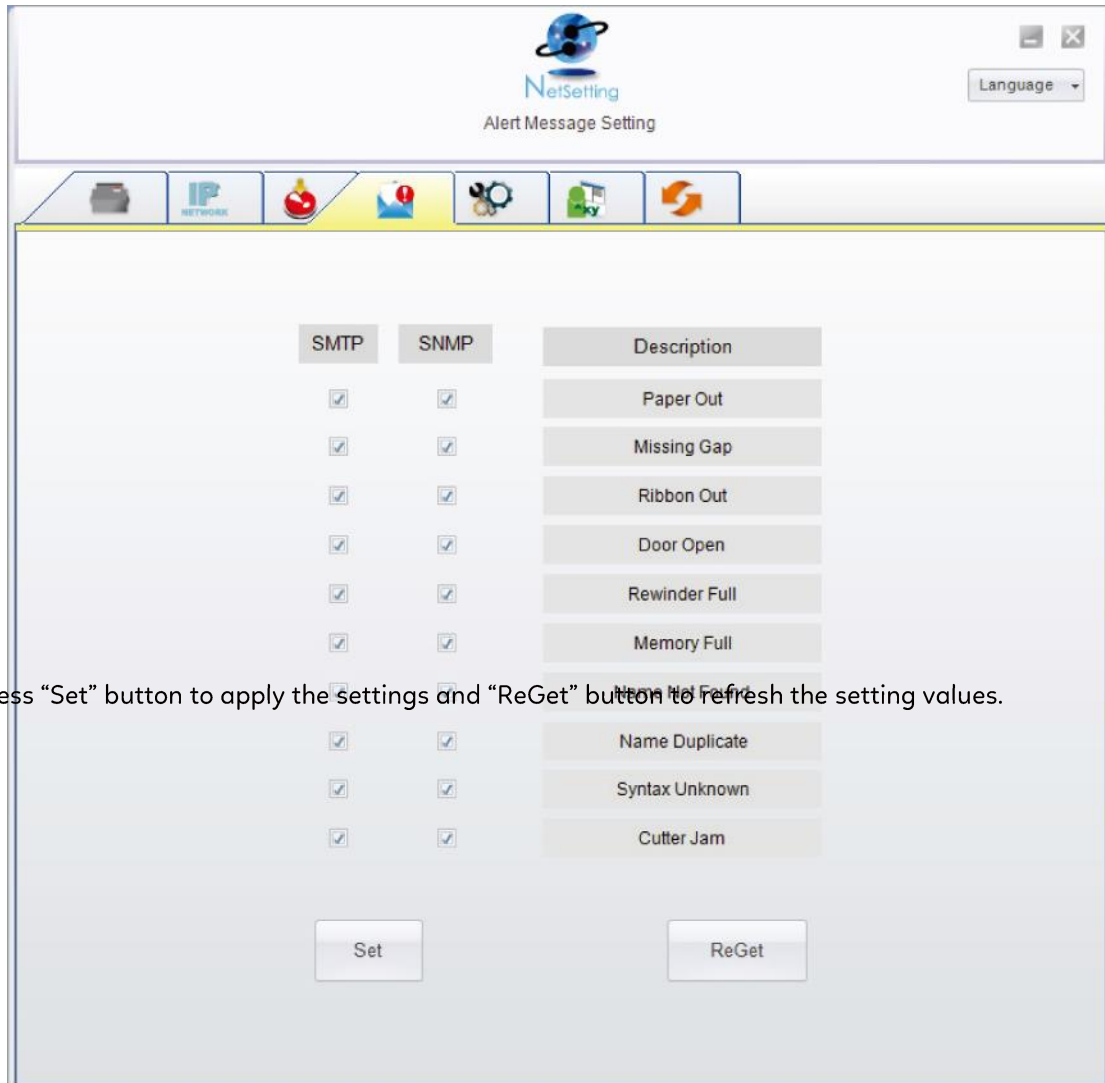

You can press "Set" button to apply the settings and "ReGet" button to refresh the setting values.

Printer Configuration

Set or change the configurations of connected printer. Most of key settings for the printer operation can be done by this setting page.

Printer Configuration

Language

Printer Setup

Printer Model	Resolution	Speed	Darkness	Stripper/Applicator	Labels per Cut	Printing Mode
DT200i+	203	4	10	0 (None)	0	Thermal Transf

PC Com Port Settings

Baud Rate	9600
Parity	None
Data Bits	8
Stop Bits	1

Miscellaneous

LCD Language	Sensing Mode	2 - Automatic
Keyboard Language	Smart Backfeed	OFF
Code Page	Top Of Form	ON
Code Page 850	Buzzer	ON

Set ReGet

You can press “Set” button to apply the settings and “ReGet” button to refresh the setting values.

User Command

The "User Command" tab provides a communication interface for operator to control the printer. Input printer commands in "Input Command" window and press "Send Command" button, the commands will be sent to the printer.

For some commands that will return response message, the message will be displayed in "Output Message" window.

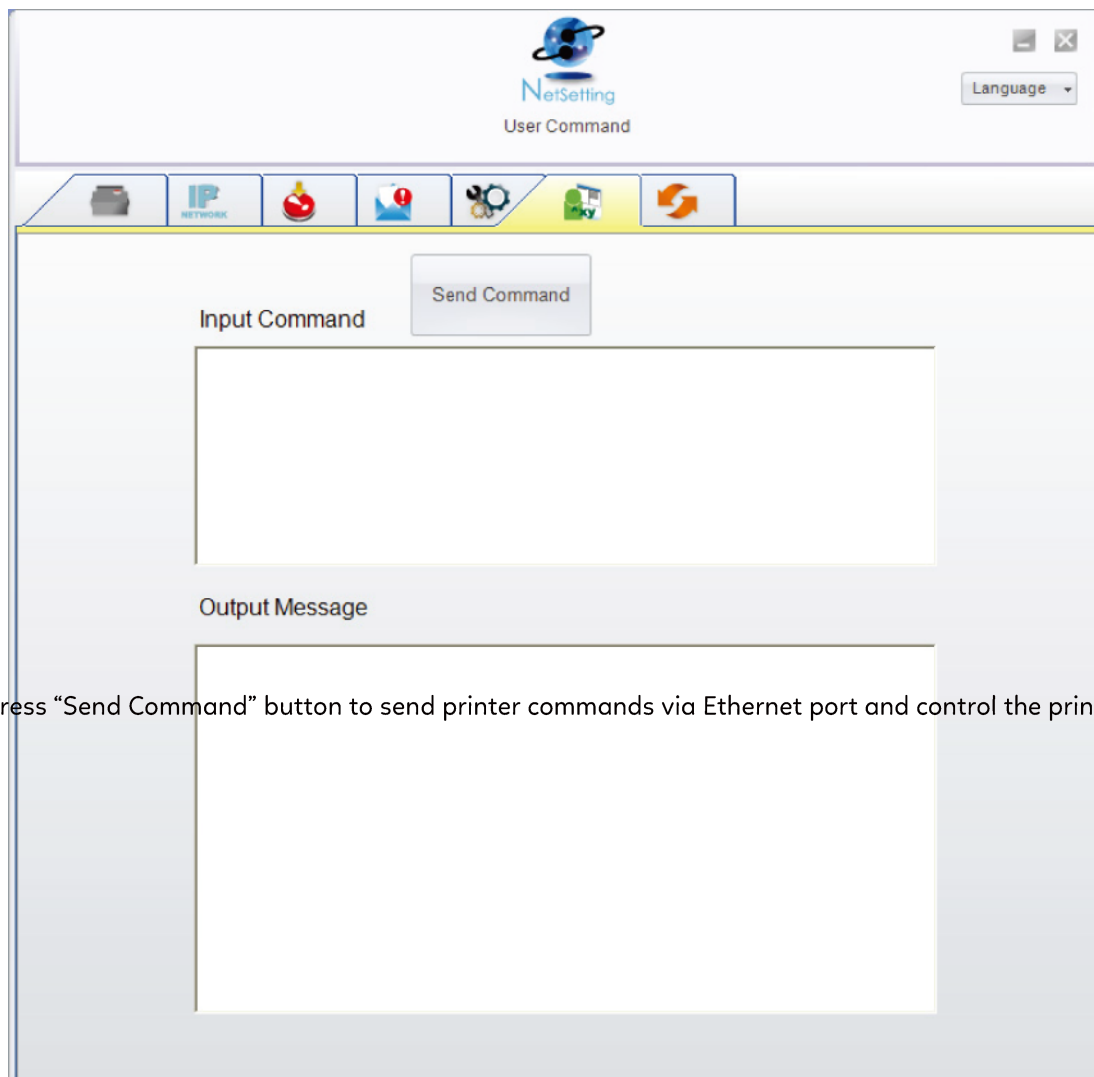

You can press "Send Command" button to send printer commands via Ethernet port and control the printer remotely.

Firmware Download

On “Firmware Download” tab, the current version of printer firmware will be showed on the screen. If you need to update the printer firmware, just specify the file location of firmware file and press “Start Download Firmware” button.

The printer firmware then can be updated remotely.

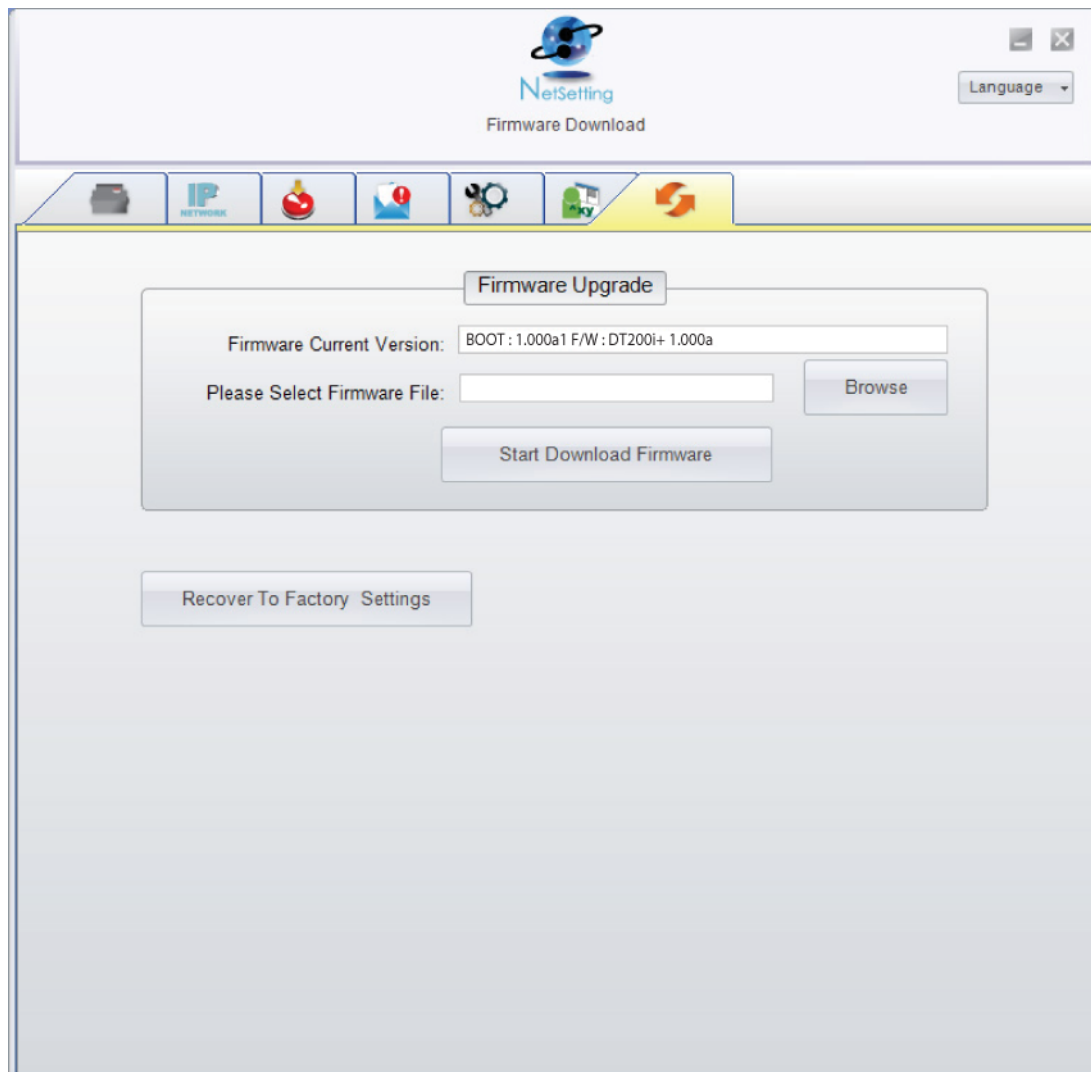

In addition to the firmware update, you can press “Recover To Factory Settings” button to restore the printer configurations back to factory default.

5. Maintenance and Adjustment

5.1 Cleaning the Print Head

Dirt on the print head or ribbon, or glue residue from the label stock may result in inadequate print quality. The printer cover must therefore always be closed during printing. Keeping dirt and dust away from the paper or labels ensures a good print quality and a longer lifespan of the print head.

Cleaning Steps

Here is how you clean the print head.

1. Turn off the printer.
2. Open the printer cover.
3. Remove the ribbon.
4. To remove any label residue or other dirt from the print head (see red arrow), please use a soft lint-free cloth dipped in alcohol.

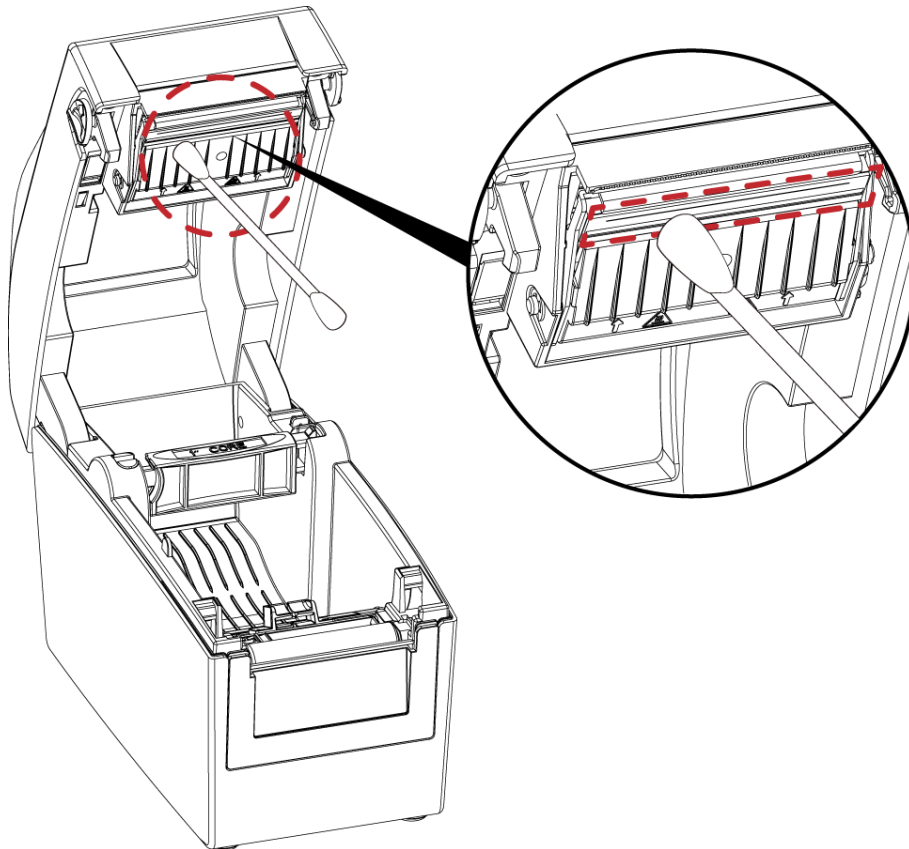

Notice

* The print head should be cleaned once a week.

* Please make sure that there are no metal fragments or other hard particles on the soft cloth used to clean the print head.

5.2 Cleaning the Platen and Label Guide

Dirt on the platen and label guide or glue residue from the label stock may result in inadequate print quality.

The printer cover must therefore always be closed during printing. Keeping dirt and dust away from the paper or labels ensures a good print quality and a longer lifespan of the platen.

Cleaning Steps

1. Turn off the printer.
2. Open the printer cover.
3. The platen and label guide (see red area), dirt or glue residue on the platen be cleaned with cotton bud. (Do not use alcohol to clean the Linerless models.)

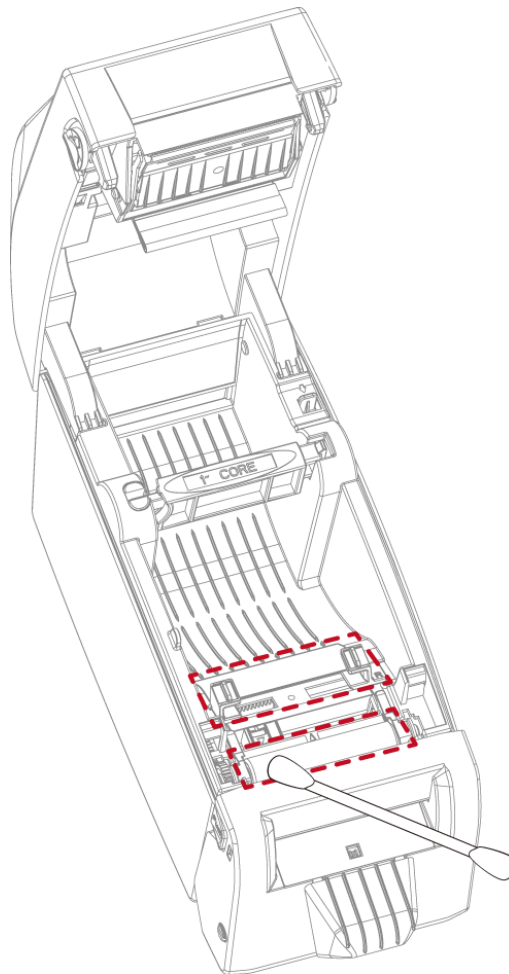

Note

* Please clean the cutter once a month or after 1,000 cuts to prevent trouble and retain the print quality.

5.3 Cleaning the Cutter

※ Please make sure to power off the printer before you clean it.

It is recommended to use a soft lint-free cloth or cotton bud to clean the cutter.

(Do not use alcohol to clean the Linerless models.)

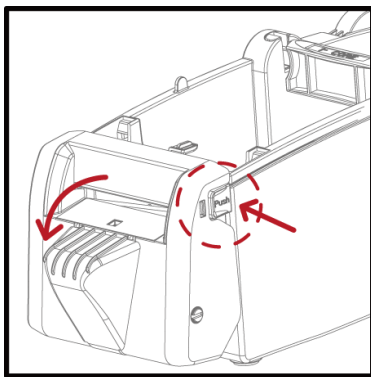
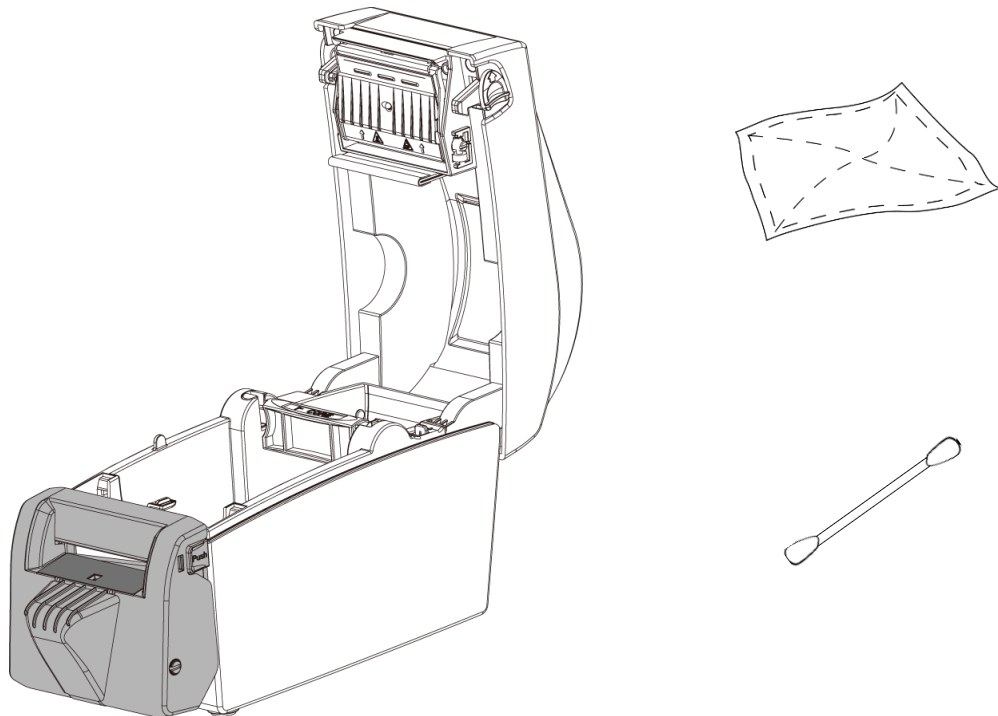

Open the cutter cover.

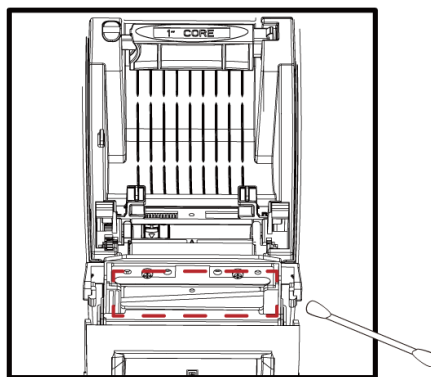

Swipe across the surface of cutter with a soft lint-free cloth or cotton bud

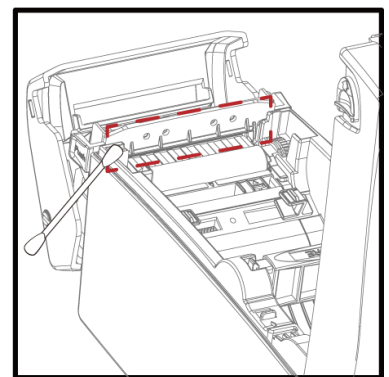

Swipe across the surface of cutter with a soft lint-free cloth or cotton bud

Note

- * Please clean the cutter once a month or after 1,000 cuts to prevent trouble and retain the print quality.
- * Please do not touch the cutter blade with bare hands.
- * When cleaning the cutter blade, make sure that the printer power is turned off and disconnect the power cable from the electrical outlet.

5.4 Troubleshooting

Problem	Solution
The printer is switched on but the LCD screen does not light up.	<ul style="list-style-type: none"> ● Check the power supply.
The LCD screen show the notice icon and printing is interrupted.	<ul style="list-style-type: none"> ● Check the software settings (driver settings) or command codes. ● Look for the error alert in the table in Section 3.9. Error Alerts. ● Check whether the print mechanism is closed correctly.
The label stock passes through the printer but no image is printed.	<ul style="list-style-type: none"> ● Choose the correct printer driver. ● Choose the correct label stock and a suitable printing mode.
The label stock jams during printing.	<ul style="list-style-type: none"> ● Clear the paper jam. Remove any label material left on the thermal print head and clean the print head using a soft lint-free cloth dipped in alcohol.
There is no printed image on some parts of the label.	<ul style="list-style-type: none"> ● Check whether any label material or ribbon is stuck to the thermal print head. ● Check for errors in the application software. ● Check whether the starting position has been set incorrectly. ● Check the ribbon for wrinkles.
There is no printed image on part of the label or the image is blurred.	<ul style="list-style-type: none"> ● Check the thermal print head for dust or other dirt. ● Use the internal “~T” command to check whether the thermal print head will carry out a complete print job. ● Check the quality of the print medium.
The printed image is positioned incorrectly.	<ul style="list-style-type: none"> ● Check whether there is paper or dust covering the sensor. ● Check whether the label stock is suitable. Contact your supplier. ● Check the paper guide settings.
A label is missed out during printing.	<ul style="list-style-type: none"> ● Check the label height setting. ● Check whether there is dust covering the sensor. ● Run the auto-detection function.
The printed image is blurred.	<ul style="list-style-type: none"> ● Check the darkness setting. ● Check the thermal print head for dust or dirt. <p>Please see the Section 5.1</p>
The cutter does not cut off the labels in a straight line.	<ul style="list-style-type: none"> ● Check whether the label stock is positioned straight.
The cutter does not cut off the labels completely.	<ul style="list-style-type: none"> ● Check whether the label is more than 0.2 mm thick
When using the cutter, the labels are not fed through or cut off incorrectly.	<ul style="list-style-type: none"> ● Check whether the cutter has been correctly installed. ● Check whether the paper guides are functioning correctly.
The label dispenser is not functioning normally.	<ul style="list-style-type: none"> ● Check whether there is dust on the label dispenser. ● Check whether the label stock is positioned correctly.

Appendix

DT200+ series Printer Specification

Model		DT200+	DT230+	DT200i+	DT230i+
Print Method		Direct Thermal			
Resolution		203 dpi (8 dots/mm)	300 dpi (12 dots/mm)	203 dpi (8 dots/mm)	300 dpi (12 dots/mm)
Print Speed		Up to 7 IPS (178 mm/s)	Up to 5 IPS (127 mm/s)	Up to 7 IPS (178 mm/s)	Up to 5 IPS (127 mm/s)
Print Width		2.12" (54 mm)	2.24" (57 mm)	2.12" (54 mm)	2.24" (57 mm)
Print Length		Min. 0.12" (3 mm)**; Max. 539.37" (13,700 mm)	Min. 0.12" (3 mm)**; Max. 236.22"(6,000 mm)	Min. 0.12" (3 mm)**; Max. 539.37" (13,700 mm)	Min. 0.12" (3 mm)**; Max. 236.22"(6,000 mm)
Processor		32 Bit RISC CPU			
Memory		Flash SDRAM 128 MB 128 MB			
Sensor Type		Adjustable reflective sensor (full range). Fixed transmissive sensor. Central aligned.			
Media		Types Width Thickness Label Roll Diameter Core Diameter Continuous form, gap labels, black mark sensing, and punched hole; label length set by auto sensing or programming Min. 0.6" (15 mm) – Max. 2.36" (60 mm) 0.0024" (0.06 mm) Min. - 0.008" (0.2 mm) Max. Max. 5" (127 mm) 1" (25.4 mm), 1.5" (38.1 mm)			
Printer Language		EZPL, GEPL, GZPL, GDPL auto switch			
Software		Label Design Tool Management Tools APP for Printing GoLabel II (for EZPL only) (Windows) GoTools (Windows / Android) GoUtility (Windows) GoAPP (Android / iOS)			
Driver		Windows 7, Windows 8 & 8.1, Windows 10, Window11, Windows Server 2008 R2, 2012, 2012 R2, 2016, 2019, 2022, MAC, Linux			
SDK		Win CE, .NET, Windows 7, Windows 8 & 8.1, Windows 10, Windows 11, Android, Mac, iOS 6, 8, 10, 12, 14, 18, 24, 30, 16X26 and OCR A&B			
Resident Fonts		Bitmap Fonts TTF Fonts 0°, 90°, 180°, 270° rotatable, single characters 0°, 90°, 180°, 270° rotatable 8 times expandable in horizontal and vertical directions (Bold / Italic / Underline) 0°, 90°, 180°, 270° rotatable Internal TTF Fonts x5 : Traditional Chinese, Simplified Chinese, Japanese, Korean, Western languages			
Download Fonts		Bitmap Fonts Asian Fonts TTF Fonts 0°, 90°, 180°, 270° rotatable, single characters 0°, 90°, 180°, 270° rotatable 16x16, 24x24. Traditional Chinese (BIG-5), Simplified Chinese (GB2312), Japanese (S-JIS), Korean (KS-X1001) 0°, 90°, 180°, 270° rotatable and 8 times expandable in horizontal and vertical directions (Bold / Italic / Underline) . 0°,90°, 180°, 270° rotatable			
Barcodes		1-D Bar codes 2-D Bar codes China Postal Code, Codabar, Code 11, Code 32, Code 39, Code 93, Code 128 (subset A, B, C), EAN-8/EAN-13 (with 2 & 5 digits extension), EAN 128, FIM, German Post Code, GS1 DataBar, HIBC, Industrial 2 of 5 , Interleaved 2-of-5 (1 2 of 5), Interleaved 2-of-5 with Shipping Bearer Bars, ISBT-128, ITF 14, Japanese Postnet, Logmars, MSI, Postnet, Plessey, Planet 11 & 13 digit, RPS 128, Standard 2 of 5, Telepen, Matrix 2 of 5, UPC-A/UPC-E (with 2 or 5 digit extension), UCC/EAN-128 K-Mart, Random Weight and Pharmacode Aztec code, Code 49, Codablock F , Datamatrix code, MaxiCode, Micro PDF417, Micro QR code, PDF417, QR code, TLC 39, GS1 Composite, DotCode, Marco PDF 417			
Code Pages		Codepage 437, 737,850, 851, 852, 855, 857, 860, 861, 862, 863, 865, 866, 869 Windows 1250, 1251, 1252, 1253, 1254, 1255, 1257 Unicode UTF8 · UTF16BE · UTF16LE			
Graphics		Resident graphic file types are BMP and PCX, other graphic formats are downloadable from the software			
Interfaces		USB 2.0 (Type B) Serial port (RS-232) Ethernet 10/100 Mbps USB Host (Type A)			
Control Panel		Two LEDs : Ready, Status Power on / off button Calibration button Control key : FEED Option		Color TFT LCD with navigation button Power on/off button Calibration button Control key: FEED Standard	
Real Time Clock		Option			
Power		Auto Switching 100-240V AC, 50-60Hz			
Environment		Operation Temperature Storage Temperature 41°F to 104°F (5°C to 40°C) -4°F to 122°F (-20°C to 50°C)			
Humidity		Operation Storage 30-85%, non-condensing 10-90%, non-condensing			
Agency Approvals		CE (EMC), FCC Class B, CB, cULus, ICES-003, UKCA, ENERGY STAR (The safety certification marks may be different depending on sales regions.)			
Dimension		Length Width Height 207 mm (8.15") 112 mm (4.41") 171 mm (6.73")			
Weight		1.05 kg (2.31 lbs), exclusive consumables			
Options		Cutter module (Dealer Install) Label dispenser (Dealer Install) BT (Dealer Install) Wireless LAN (Dealer Install) WiFi module to WiFi and BT (BLE 5.0) combo module (Dealer Install) External label unwind stand External label rewinder Real time clock (RTC)		Cutter module (Dealer Install) Label dispenser (Dealer Install) BT (Dealer Install) Wireless LAN (IEEE 802.11 b/g/n) (Dealer Install) WiFi module to WiFi (IEEE 802.11 b/g/n) and BT (BLE 5.0) combo module (Dealer Install) External label unwind stand External label rewinder	

*Specifications are subject to change without notice. All company and/or product names are trademarks and/or registered trademarks of their respective owners.

**Minimum print height and maximum print speed specification compliance can be dependent on non-standard material variables such as label type, thickness, spacing, liner construction, etc. GoDEX is pleased to test non-standard materials for minimum print height, and maximum print speed capability.

***The cutter is an optional accessory. If the cutter is installed, it is not suitable for children to approach.

DT200L+ series Printer Specification

Model		DT200L+	DT230L+	DT200iL+	DT230iL+
Print Method		Direct Thermal			
Resolution		203 dpi (8 dots/mm)	300 dpi (12 dots/mm)	203 dpi (8 dots/mm)	300 dpi (12 dots/mm)
Print Speed		Up to 6 IPS (152 mm/s)	Up to 5 IPS (127 mm/s)	Up to 6 IPS (152 mm/s)	Up to 5 IPS (127 mm/s)
Print Width		2.12" (54 mm)	2.24" (57 mm)	2.12" (54 mm)	2.24" (57 mm)
Print Length		Min. 0.12" (3 mm)** ; Max . 539.37" (13,700 mm)	Min. 0.12" (3 mm)** ; Max. 236.22" (6,000 mm)	Min. 0.12" (3 mm)** ; Max . 539.37" (13,700 mm)	Min. 0.12" (3 mm)** ; Max. 236.22" (6,000 mm)
Processor		32 Bit RISC CPU			
Memory		Flash SDRAM 128 MB 128 MB			
Sensor Type		Adjustable reflective sensor (half range). Fixed transmissive sensor. Central aligned.			
Media		Types Continuous linerless label; label length set by auto sensing or programming Width Min. 0.6" (15 mm) – Max. 2.36" (60 mm) Thickness 0.0024" (0.06 mm) Min. - 0.004" (0.1 mm) Max. Label Roll Diameter Max. 5" (127 mm) Core Diameter 1" (25.4 mm), 1.5" (38.1 mm)			
Printer Language		EZPL, GEPL, GZPL, GDPL auto switch			
Software		Label Design Tool GoLabel II (for EZPL only)(Windows) Management Tools GoTools (Windows/ Android) GoUtility (Windows) APP for Printing GoAPP (Android/ iOS)			
Driver SDK		Windows 7, Windows 8 & 8.1, Windows 10, Window11, Windows Server 2008 R2, 2012, 2012 R2, 2016, 2019, 2022, MAC, Linux Win CE, .NET, Windows 7, Windows 8 & 8.1, Windows 10, Windows 11, Android, Mac, iOS			
Resident Fonts		Bitmap Fonts 0°, 90°, 180°, 270° rotatable, single characters 0°, 90°, 180°, 270° rotatable 8 times expandable in horizontal and vertical directions TTF Fonts (Bold / Italic / Underline) 0°, 90°, 180°, 270° rotatable Internal TTF Fonts x5 : Traditional Chinese, Simplified Chinese, Japanese, Korean, Western languages			
Download Fonts		Bitmap Fonts 0°, 90°, 180°, 270° rotatable, single characters 0°, 90°, 180°, 270° rotatable Asian Fonts 16x16, 24x24. Traditional Chinese (BIG-5), Simplified Chinese(GB2312), Japanese (S-JIS), Korean (KS-X1001) TTF Fonts 0°, 90°, 180°, 270° rotatable and 8 times expandable in horizontal and vertical directions (Bold / Italic / Underline) . 0°,90°, 180°, 270° rotatable			
Barcodes		1-D Bar codes China Postal Code, Codabar, Code 11, Code 32,Code 39, Code 93, Code 128 (subset A, B, C), EAN-8/EAN-13 (with 2 & 5 digits extension), EAN 128, FIM, German Post Code, GS1 DataBar, HIBC, Industrial 2 of 5, Interleaved 2-of-5 (1 2 of 5), Interleaved 2-of-5 with Shipping Bearer Bars, ISBT-128, ITF 14, Japanese Postnet, Logmars, MSI, Postnet, Plessey, Planet 11 & 13 digit, RPS 128, Standard 2 of 5, Telepen, Matrix 2 of 5, UPC-A/UPC-E (with 2 or 5 digit extension), UCC/EAN-128 K-Mart, Random Weight and Pharmacode 2-D Bar codes Aztec code, Code 49,Codablock F , Datamatrix code, MaxiCode, Micro PDF417, Micro QR code, PDF417,QR code, TLC 39, GS1 Composite, DotCode, Marco PDF 417			
Code Pages		Codepage 437, 737,850, 851, 852, 855, 857, 860, 861, 862, 863, 865, 866, 869 Windows 1250, 1251, 1252, 1253, 1254, 1255, 1257 Unicode UTF8 、 UTF16BE 、 UTF16LE			
Graphics		Resident graphic file types are BMP and PCX, other graphic formats are downloadable from the software			
Interfaces		USB 2.0 (Type B) Serial port (RS-232) Ethernet 10/100 Mbps USB Host (Type A)			
Control Panel		Two LEDs : Ready, Status Power on / off button Calibration button Control key : FEED		Color TFT LCD with navigation button Power on/off button Calibration button Control key: FEED	
Real Time Clock		Option		Standard	
Power		Auto Switching 100-240V AC, 50-60Hz			
Environment		Operation Temperature 41°F to 104°F (5°C to 40°C) Storage Temperature -4°F to 122°F (-20°C to 50°C)			
Humidity		Operation 30-85%, non-condensing Storage 10-90%, non-condensing			
Agency Approvals		CE (EMC) 、 FCC Class B 、 CB 、 cULus 、 ICES-003, UKCA, ENERGY STAR <i>(The safety certification marks may be different depending on sales regions.)</i>			
Dimension		Length 219 mm (8.62") Width 112 mm (4.41") Height 171 mm (6.73")			
Weight		1.07 kg(2.36 lbs), exclusive consumables			
Options		Linerless Cutter module (Dealer Install) BT (Dealer Install) Wireless LAN (Dealer Install) WiFi module to WiFi and BT (BLE 5.0) combo module (Dealer Install) Real time clock (RTC)		Linerless Cutter module (Dealer Install) BT (Dealer Install) Wireless LAN (Dealer Install) WiFi module to WiFi and BT (BLE 5.0) combo module (Dealer Install)	

*Specifications are subject to change without notice. All company and/or product names are trademarks and/or registered trademarks of their respective owners.

**Minimum print height and maximum print speed specification compliance can be dependent on non-standard material variables such as label type, thickness, spacing, liner construction, etc. GoDEX is pleased to test non-standard materials for minimum print height, and maximum print speed capability.

***The cutter is an optional accessory. If the cutter is installed,it is not suitable for children to approach.

Interface

Pinout Description

- USB

Connector Type : Type B

Pin NO.	1	2	3	4
Function	VBUS	D-	D+	GND

- Serial port

Default settings : Baud rate 9600, no parity, 8 data bits, 1 stop bit, XON/XOFF protocol and RTS/CTS

RS232 Housing(9-pin to 9-pin)		
DB9 Socket		DB9 Plug
-		+5V, max 500mA
RXD	1_____1	TXD
TXD	2_____2	RXD
DTR	3_____3	N/C
GND	4_____4	GND
DSR	5_____5	RTS
RTS	6_____6	CTS
CTS	7_____7	RTS
RI	8_____8	N/C
Computer	9_____9	Printer

- Ethernet

Type:RJ45

Pin NO.	1	2	3	4	5	6	7	8
	TX+	TX-	RX+	NC	NC	RX-	NC	NC

- USB host

Connector Type : Type A

Pin NO.	1	2	3	4
	VBUS	D-	D+	GND

File Manipulation When Using USB Stick

File Manipulation

The files in both devices (USB memory stick and printer internal Flash memory) are able to copy and move by the commands “~MCPY” and “~MMOV” that sends from GoLabel on a PC via either connection - USB or Ethernet ports.

- Copy

Syntax	~MCPY,s:o,x,d:o,x
Parameter	s = source device of stored object (s = D (for USB memory stick) or F (for internal Flash memory)) d = destination device of stored object o = object name , the name “o” is substituted for “*” x = extension (file type), the type “x” is substituted by “*”, or following either one: D= database, A= Asia font, C= TTF font, E= Bit-Mapped font, F= label format, G= graphic, S= serial file, T= text, B= Unicode Table.
Description	Copy file from USB memory stick to Flash memory, or vice-versa
Example	~MCPY,F:*F,D:*F (Copy entire “Label Format” files from Flash memory to USB memorystick) ~MCPY,D:*G,F:*G (Copy entire “Graphic” files from USB memory stick to Flash Memory) ~MCPY,D:**,F:*.* (Copy all object files from USB memory stick to Flash Memory)

- Move

Syntax	~MMOV,s:o,x,d:o,x
Parameter	s = source device of stored object; <ul style="list-style-type: none"> ● “D” for USB memory stick; “F” for internal Flash memory d = destination device of stored object <ul style="list-style-type: none"> ● “D” for USB memory stick; “F” for internal Flash memory o = object name (file name); the name “o” is substituted for “*” x = extension (file type), the type “x” is substituted by “*”, or following either one: D= database, A= Asia font, C= TTF font, E= Bit-Mapped font, F= label format, G= graphic, S= serial file, T= text, B= Unicode Table.
Description	Move files from USB memory stick to Flash memory or vice-versa
Example	~MMOV,F:*F,D:*F (Move entire “Label Format” files from Flash memory to USB memorystick) ~MMOV,D:*G,F:*G (Move entire “Graphic” files from USB memory stick to Flash Memory) ~MMOV,D:**,F:*.* (Move all object files from USB memory stick to Flash Memory)

Wi-Fi Printer Sever Module Installation(Quick Setting)

Set up wireless network through GoDEX WiFi tool

1. Turn on the printer,connect printer and computer by USB cable.
2. Start GoLabel II
3. "Generic"→"Printer Setup".

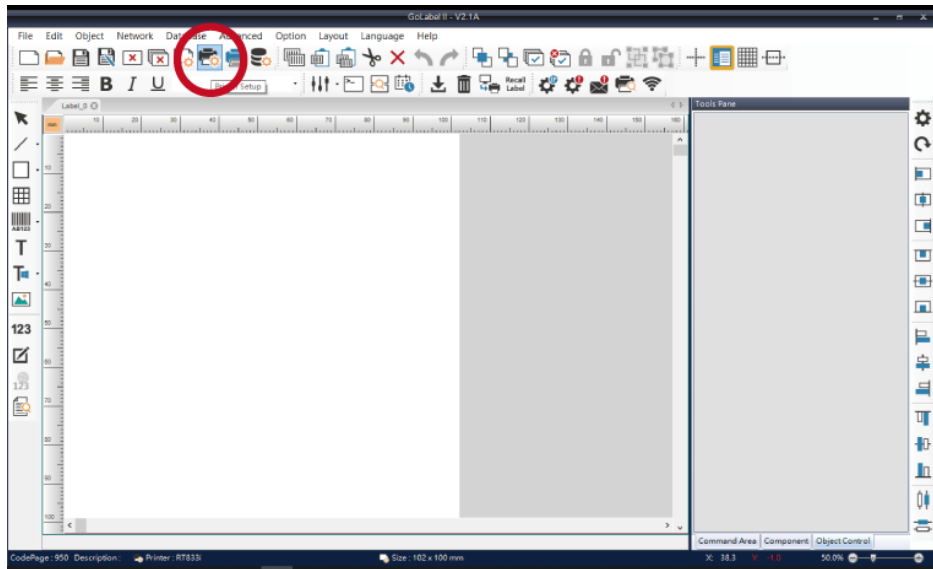

4. Select printer model(Wi-Fi supported models).

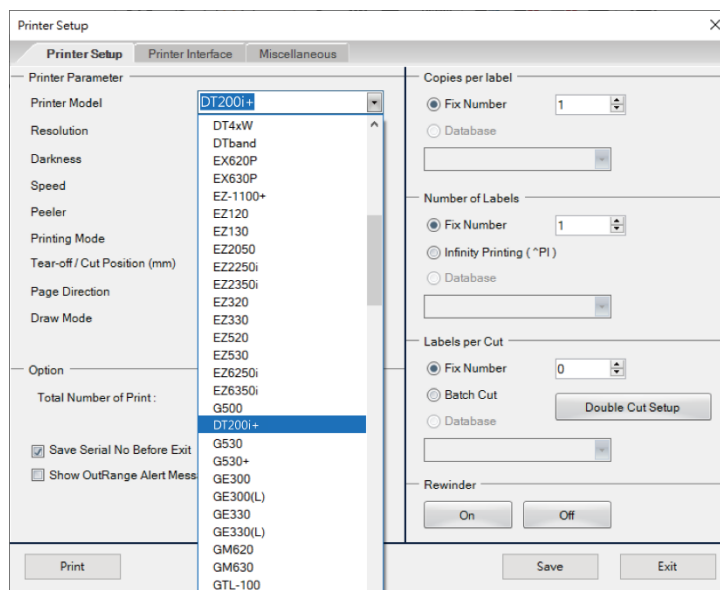

5. Click "WiFi Setting" icon.

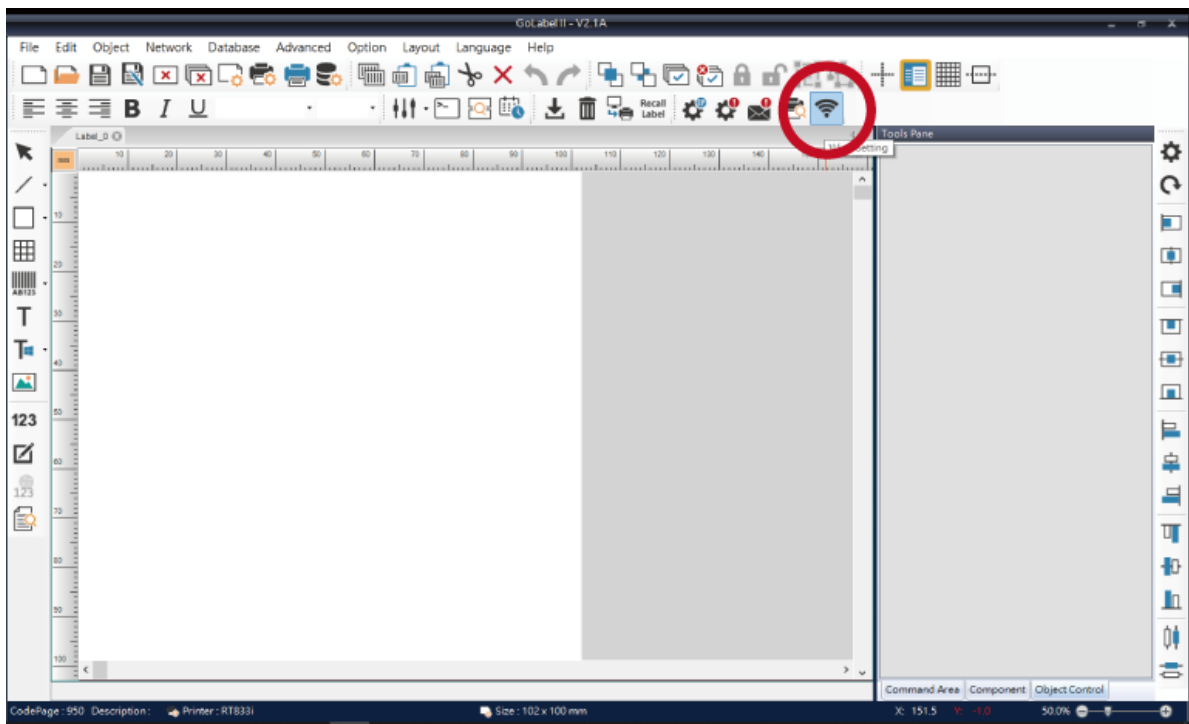

6. Click "Quick Setting" icon.

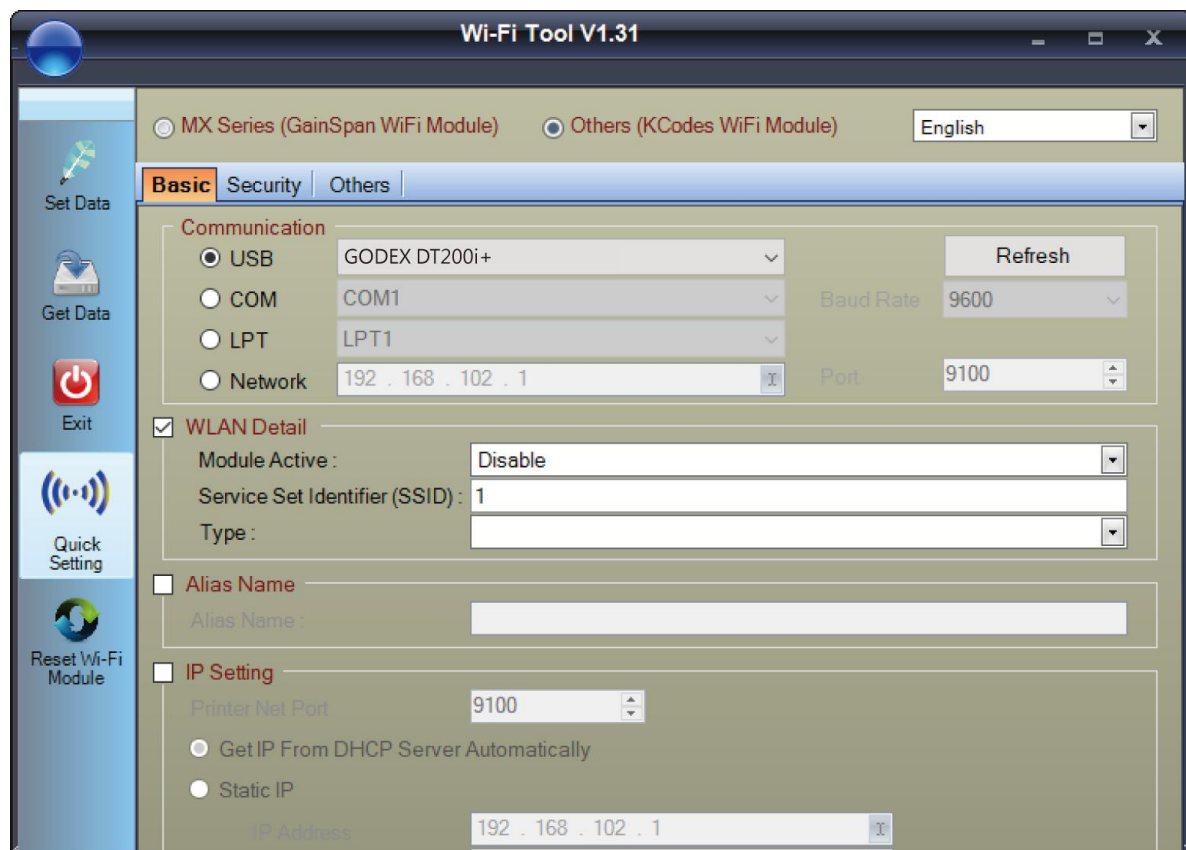

7. Click the Search button.

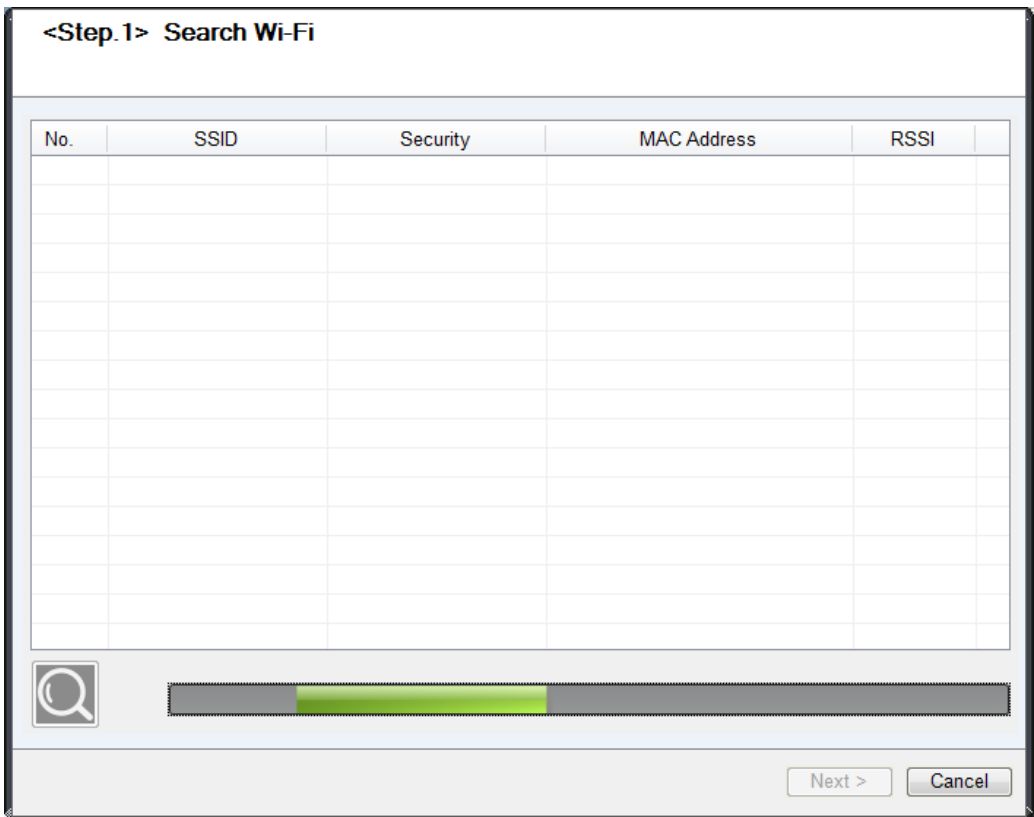
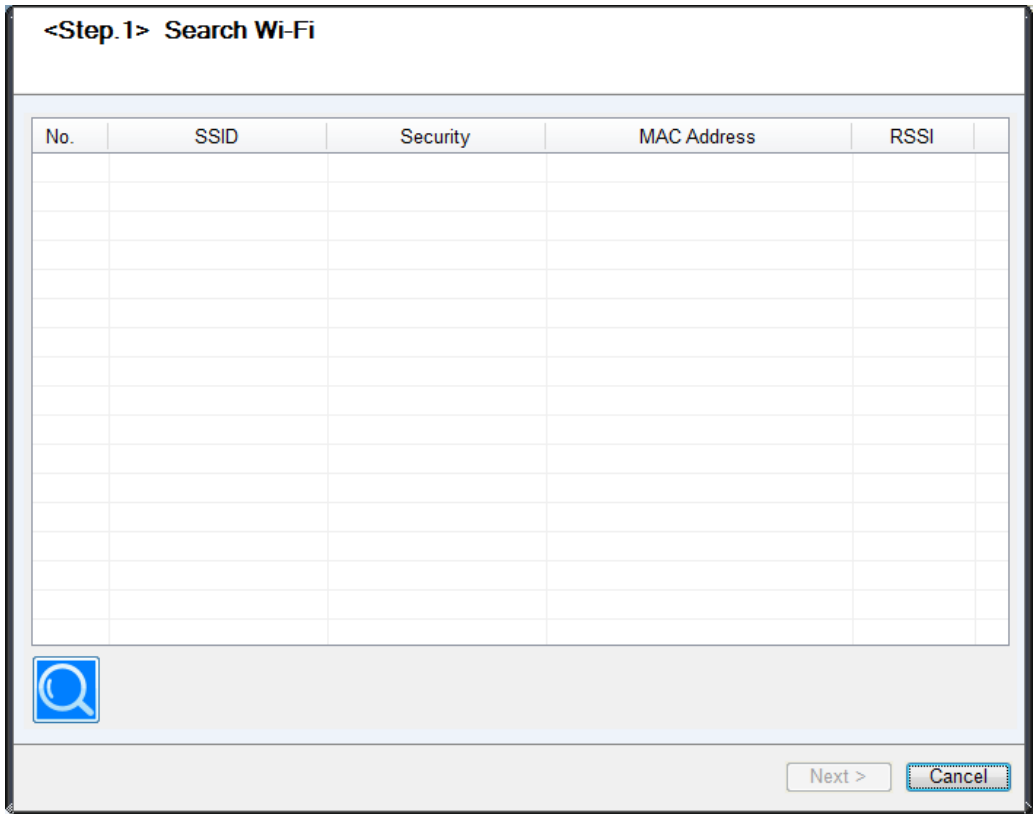

8. Select server and click **next** button.

<Step.1> Search Wi-Fi

No.	SSID	Security	MAC Address	RSSI
00	MXAP	None	D4:8C:B5:BE:AD:05	-44
01	WiFiAP	WPA2-PSK	D6:8C:B5:BE:AD:05	-44
02	WLAN51111	WEP	D2:8C:B5:BE:AD:05	-44
03	WIFIPRINTER1	None	DE:8C:B5:BE:AD:05	-44
04	GDX-BYOD	None	24:DE:C6:97:57:B0	-54
05	GDX-Guest	None	24:DE:C6:97:57:B2	-54
06	GDX-test	WPA2-PSK	24:DE:C6:97:57:B3	-56
07	GDX-BYOD	None	24:DE:C6:97:57:80	-62
08	GDX-Guest	None	24:DE:C6:97:57:82	-62
09	GDX-test	WPA2-PSK	24:DE:C6:97:57:83	-62
10	HUAWEI-B525	WPA2-PSK	10:B1:F8:14:A2:F4	-70
11	GodexAP1	WPA-AUTO	00:50:7F:4A:24:61	-72
12	WLAN511010	None	00:50:7F:4A:24:60	-74
13	ABC123	None	00:50:7F:4A:24:63	-74
14	MXAPWPA2PER	None	00:50:7F:4A:24:62	-76
15	GDX-BYOD	None	24:DE:C6:97:57:60	-78
16	GDX-Guest	None	24:DE:C6:97:57:62	-78



Next > **Cancel**

9. Enter the **password** set on the server side and click the **"Setting"** button.

<Step.2> WiFi Setting

No.

SSID Name

Security

Password 

< Back **Setting** **Cancel**

10. After the setting succeeded, a prompt will pop up and the printer will restart.

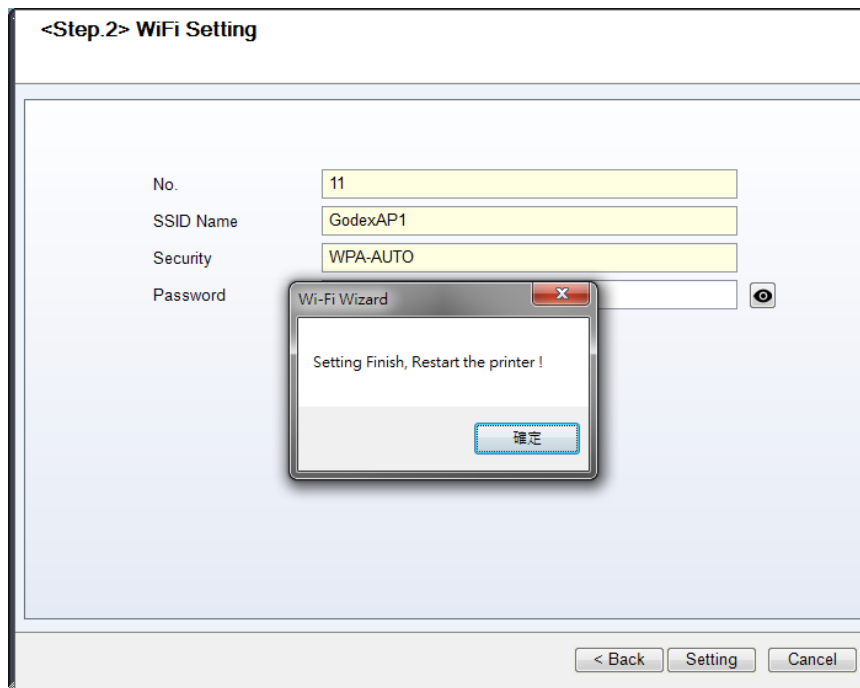

11. Select the "Other" tab and selecting "IP Settings" after click the "Get Data" icon.

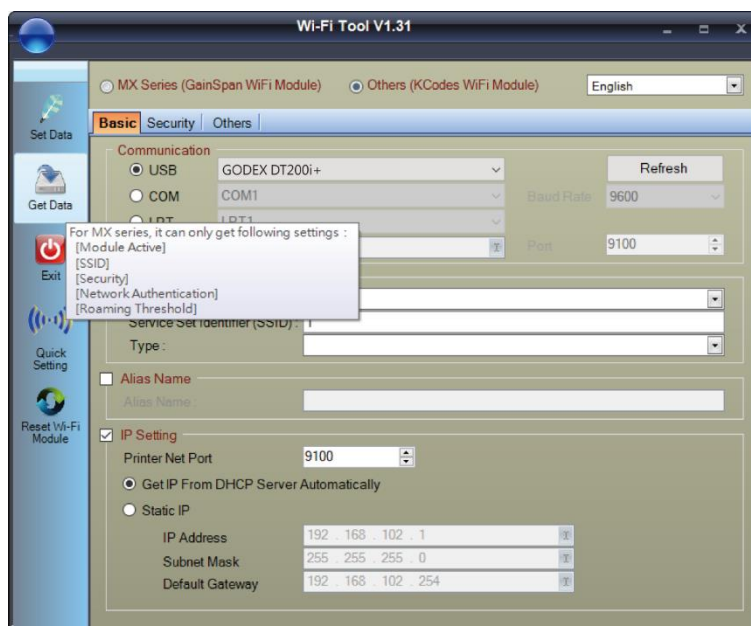

12. After remembering the IP address, open the "Printer Settings" window.

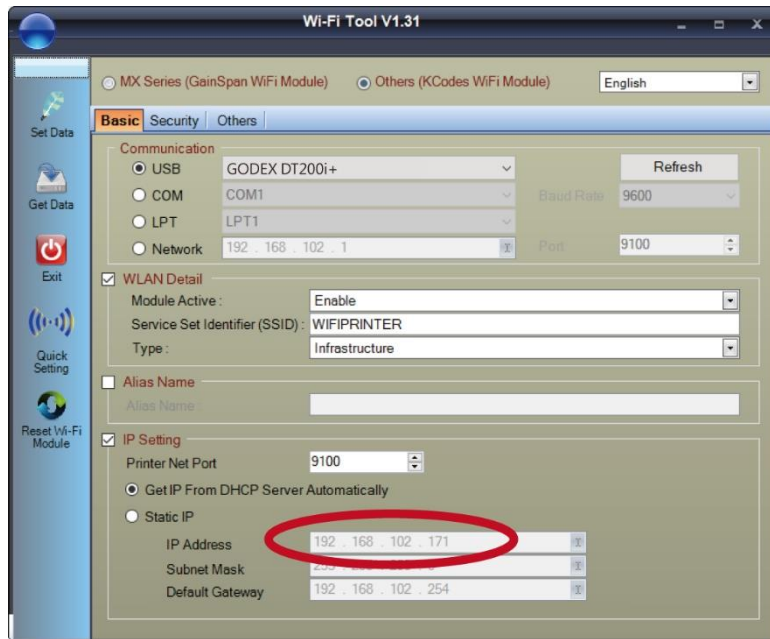

13. Select the "Printer Interface" tab, fill in the IP address and click "Save" to complete the setting.

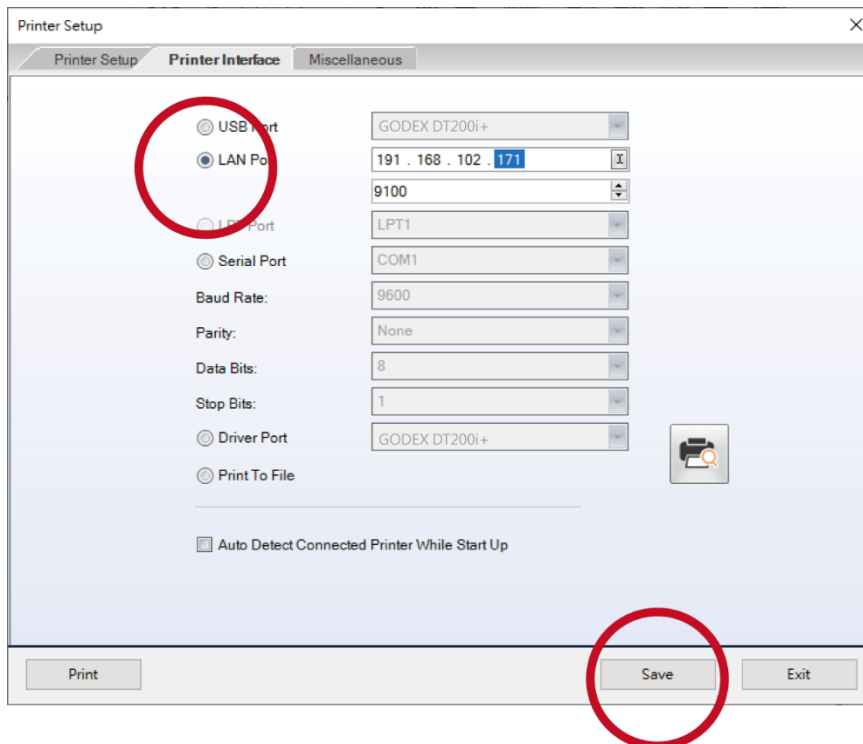

BT module setting instructions (Connect to mobile phone)

* Android applies to BT2.1 and 4.0
iOS only works with BT4.0

First pair the phone with the printer

1. Turn on the printer and wait for it to enter the "Ready" state.
2. Select the printer model you want to connect.
(The default pairing password is 0000)

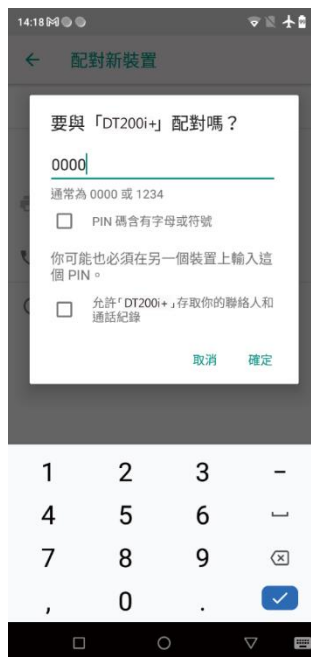
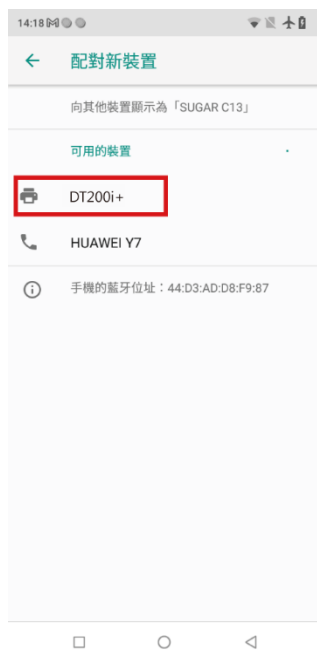

3. Open the GoApp application.



Select connection method and printer

4. For the connection method, choose "Near BT" button.

5. The printers which installed the BT module will be listed below, select the printer to connect.

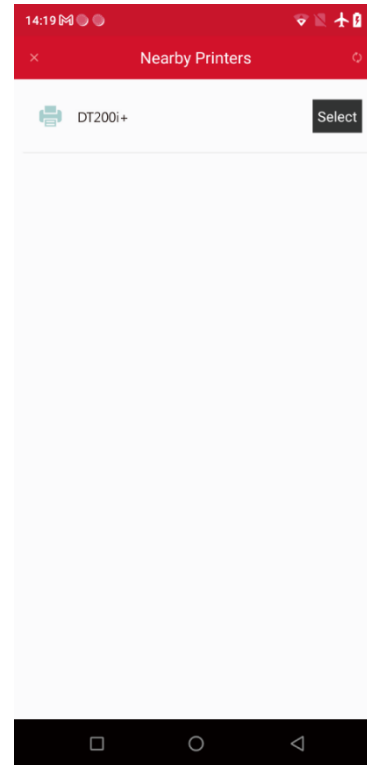
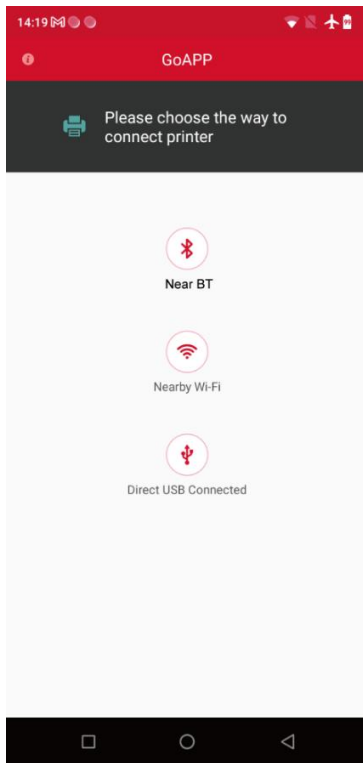

6. If the connection is successful, the function window will be displayed.

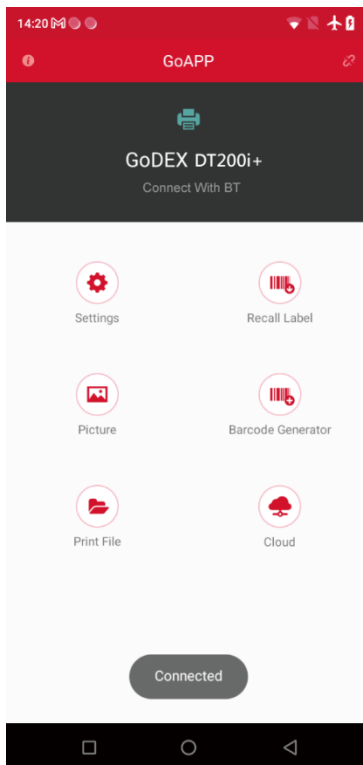

* When using the BT4.0 module, you need to use GoLabel to send the command "**^XSET,EXTERNCARDMODE,8**" to the printer first.

if you need to switch to 2.1 version, please send the command (**^XSET,EXTERNCARDMODE,255**) to ensure the correct functionality.